

Activity Book

# NUTTY'S ENGLISH 1

Iveta Gebauerová  
Dana Petru



Angličtina pre prvý ročník ZŠ

FRAUS Klett

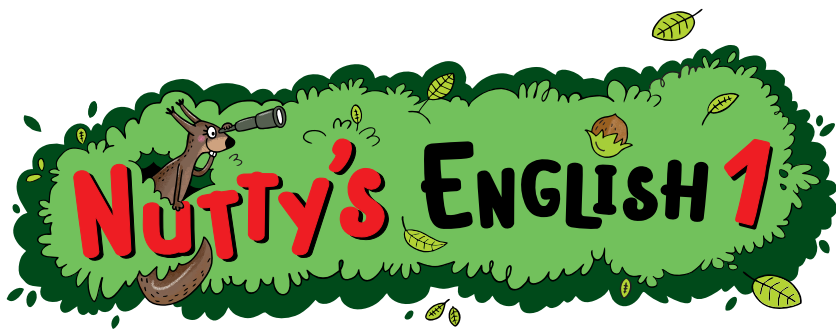

## Angličtina pre 1. ročník ZŠ



Všetky práva vyhradené. Reprodukcia a rozširovanie diela alebo jeho častí akýmkoľvek spôsobom, ako aj automatizovaná analýza textov alebo údajov v zmysle článku 4 smernice 2019/790/EÚ sú bez písomného súhlasu vydavateľa zakázané, s výnimkou prípadov, ktoré zákon výslovne povoľuje.



Obsah tohto titulu aj súvisiaci interaktívny obsah mohli vzniknúť s pomocou umelej inteligencie. Všetok obsah prešiel ľudskou kontrolou.



Kniha je za bežných podmienok používania, t. j. pri používaní na čítanie, štúdium a pod., bezpečným výrobkom v zmysle článku 3 ods. 2 nariadenia Európskeho parlamentu a Rady (EÚ) 2023/988 („GSPSR“). Vzhľadom na všeobecne známy spôsob jej používania podľa článku 9 ods. 7 GSPSR nie sú potrebné ani pokyny na bezpečnostné informácie.



Na stránke [www.vydavatelstvoklett.sk](http://www.vydavatelstvoklett.sk) sú dostupné doplnkové a rozširujúce materiály (nahrávky a videonahrávky, pracovné listy, hry, metodické pokyny) z produkcie vydavateľstva Fraus Klett, s. r. o., dostupované v elektronickej podobe.

Súčasťou **cvičení v Boosteri sú QR kódy** – jeden pre každé cvičenie. Odfotografovaním QR kódu smartfónom sa prehrá príslušná nahrávka (súbor s posluškom sa nebude sťahovať do vášho telefónu). Na prehratie posluchu musí byť telefón pripojený k internetu.

Iveta Gebauerová, Dana Petrů, Miroslava Pitschmannová

### Nutty's English 1

Activity Book

Angličtina pre prvý ročník ZŠ

© Nutty's English 1, Klett Verlag, s. r. o., Praha 2024

© autorky: Mgr. Iveta Gebauerová, Mgr. Dana Petrů

© slovenská verzia: Mgr. Miroslava Pitschmannová, Fraus Klett, s. r. o., Praha 2026

Všetky práva vyhradené.

Layout a sadba: Tetiana Osadchuk

Ilustrácie: Natália Kokhanij

Použitý obrázový materiál: shutterstock.com, archív Fraus Klett

Audionahrávky: Jan Boroš, Studio Monty, Ocelářská 15, 190 00 Praha 9

Animované videá: MgA. Andrea Malášková

Jazyková korektúra: agentura mia translate, Mgr. Ladislava Whitcroft, Ph.D., Ing. Lenka Tršová Husárová

Zodpovedná redaktorka: Mgr. Marcela Bartůňková

Tlač: Profi-tisk group s. r. o., Chválkovická 223/5, 779 00 Olomouc

Fraus Klett, s. r. o.

Pobřežní 620/3, 186 00 Praha 8 – Karlín

info@klett.sk, www.klett.sk

[vydavatelstvoklett.sk/nuttys-english](http://vydavatelstvoklett.sk/nuttys-english)

ISBN 978-80-7397-479-4

Welcome

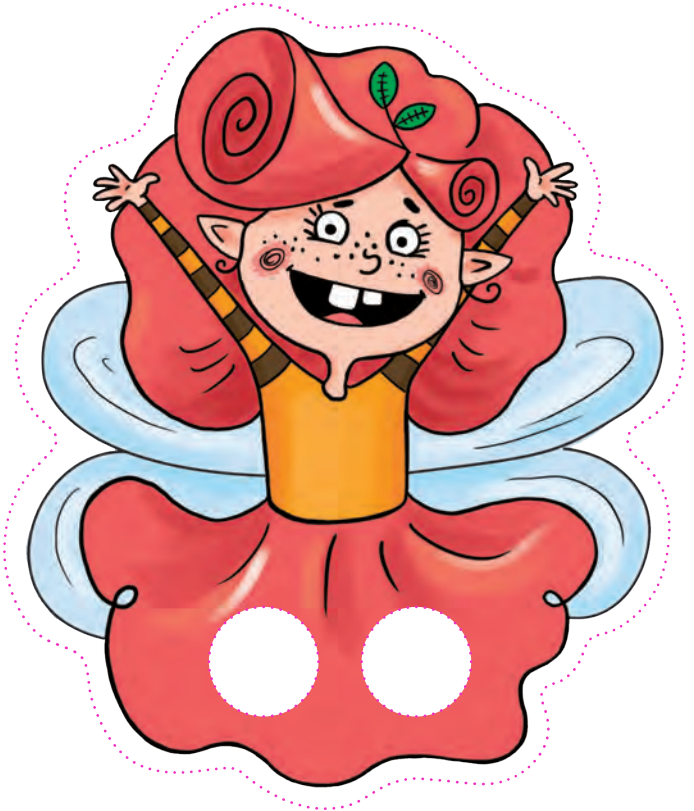

3  
Welcome



# 1A Meet our Friends



1

2

3



# 1A Extra

3



4



I'M



# 1B Meet our Friends

1

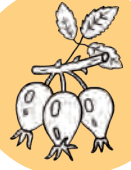

2



1

2

3

4

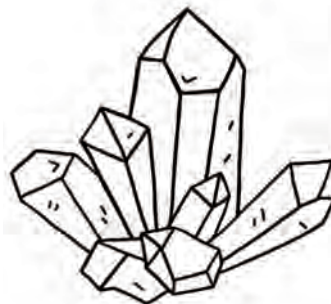

# 1B Extra

3

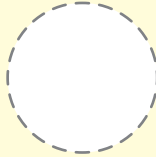
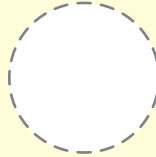
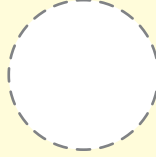
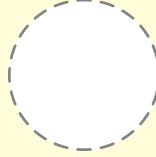

4

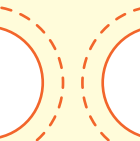
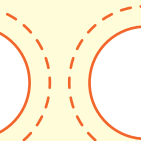
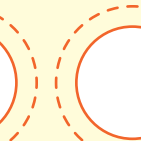
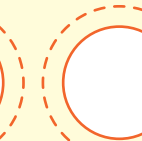
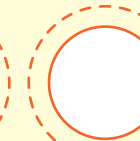
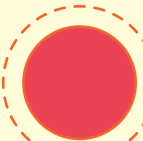
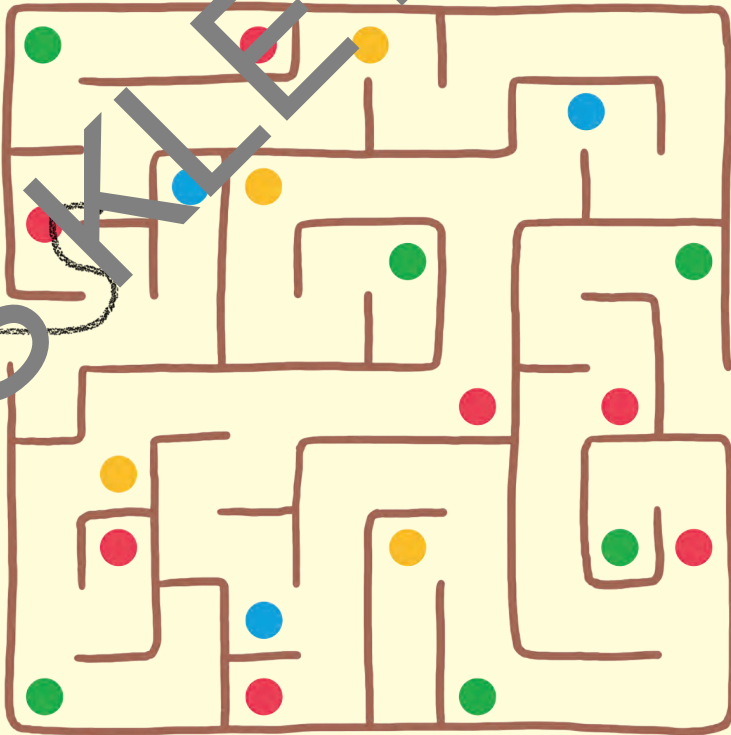

# 1C Dice & Counters

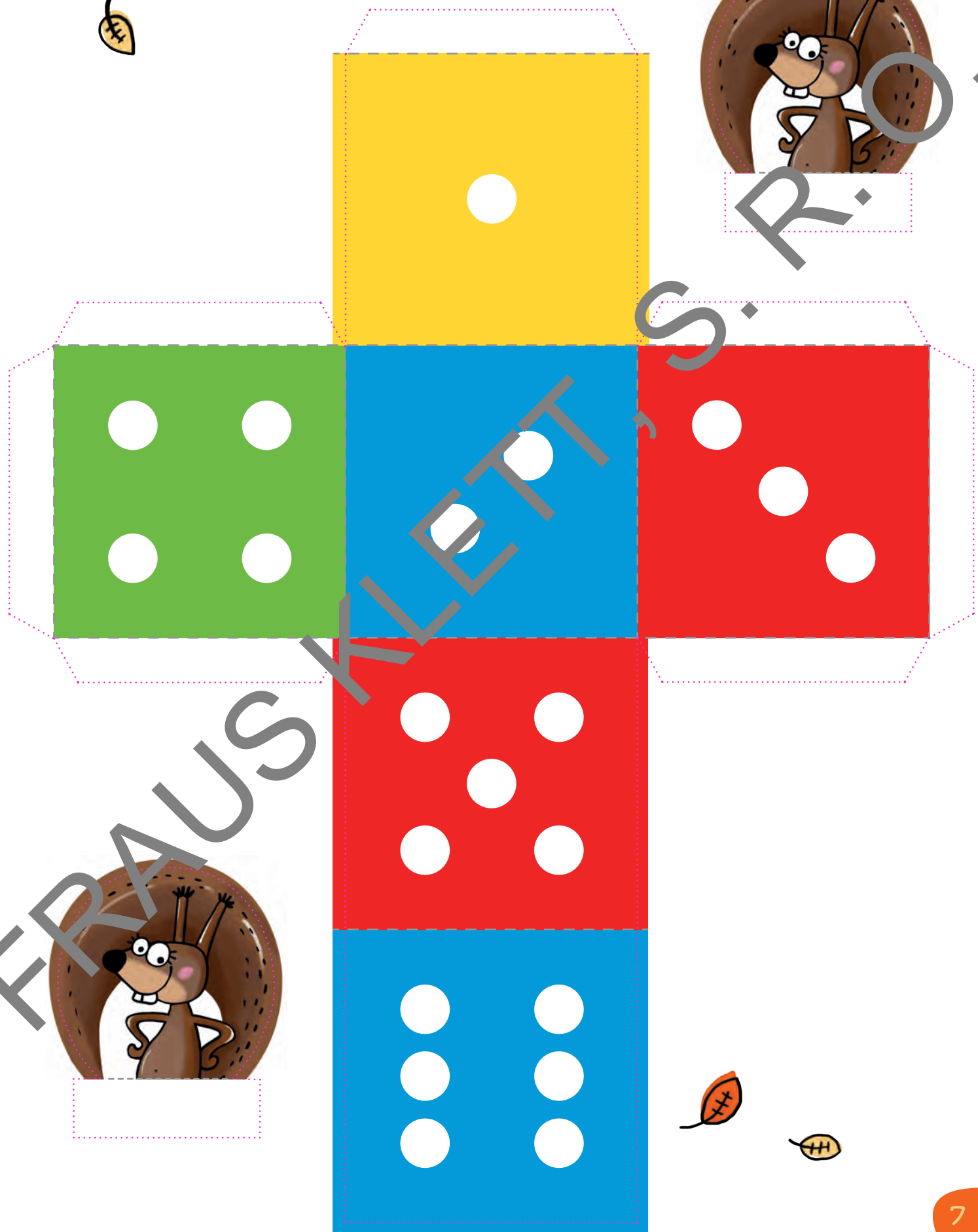

FRAUS KLETT, S.R.O.

# 1C Meet our Friends

1   

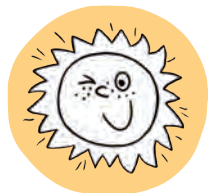

Activity area for counting nuts. It features several groups of nuts and dashed circles for counting. A large watermark 'FRÄUSKYLETT' is visible across the page.

2   

Activity area for counting logs. It features several logs shaped like numbers 1 through 6. A large watermark 'FRÄUSKYLETT' is visible across the page.

# 1C Extra

3



- 1
- 2
- 3

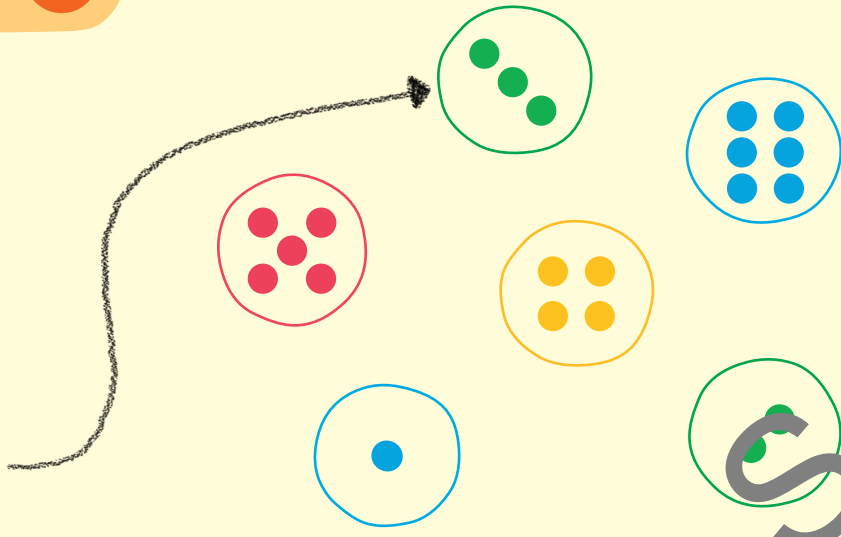

- 4
- 5
- 6

4

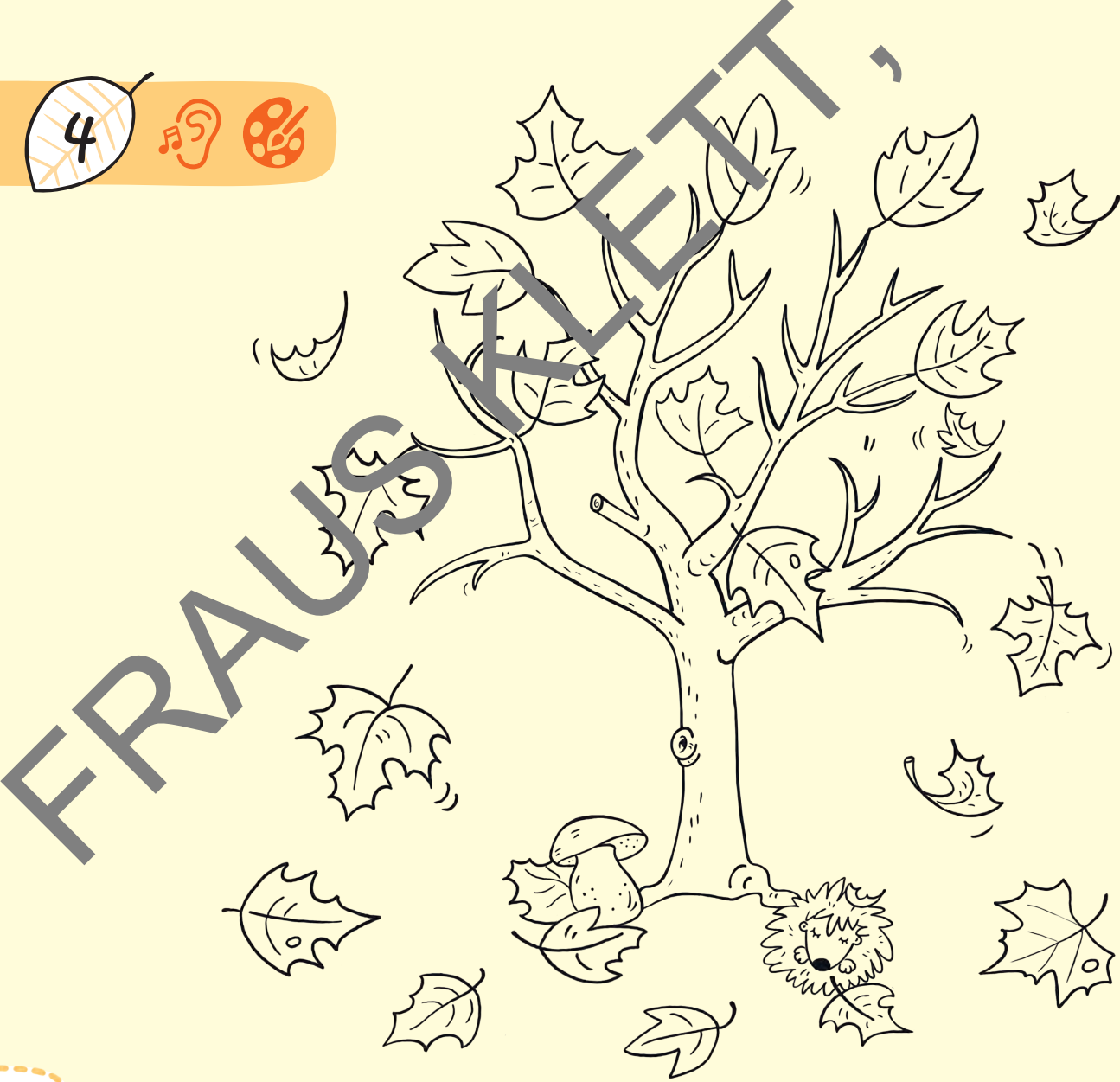

# 1D Nut Hunt



FRAUS KLETT, S.R.O.

# 2A Forest School

1



1



3

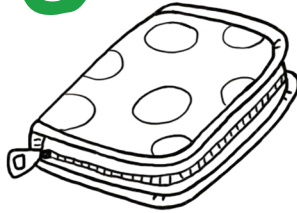

5

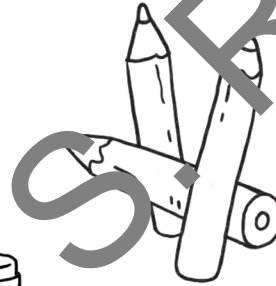

2



6



2



4

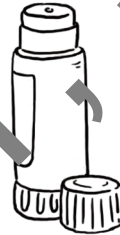

# 2A Extra

3



1



2



3



4



5



6



4

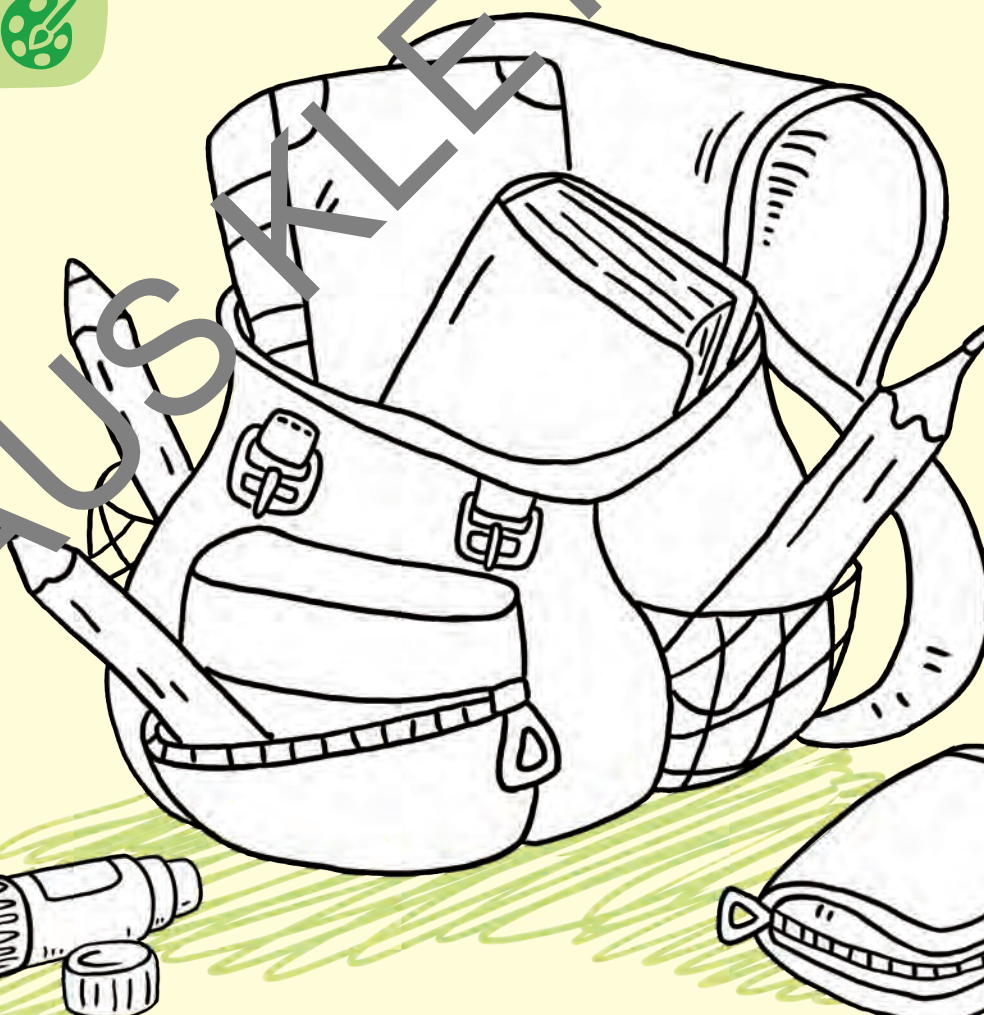

???

FRAUSKLETT, S.R.O.

# 2B Forest School



1



2

- 1 -
- 2 -
- 3 -
- 4 -
- 5 -
- 6 -

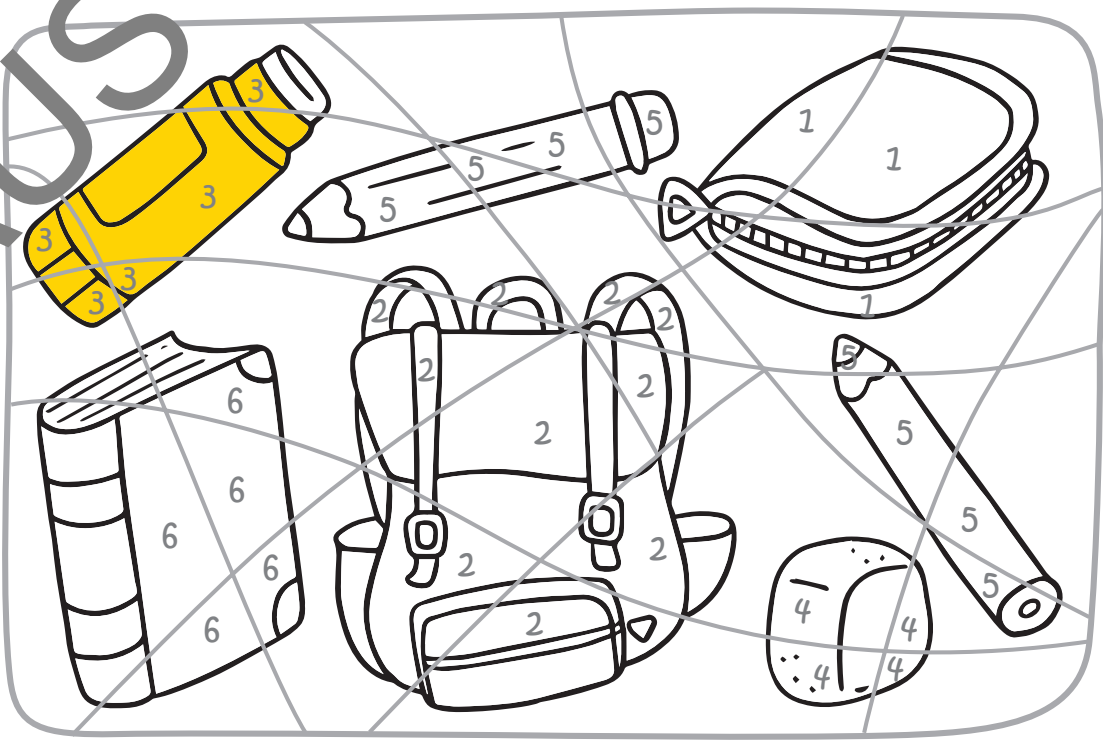

# 2B Extra

3



4



1

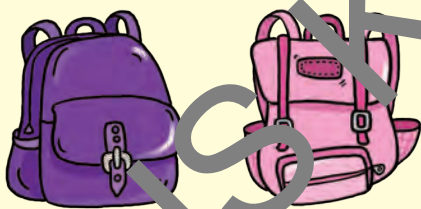

2



3

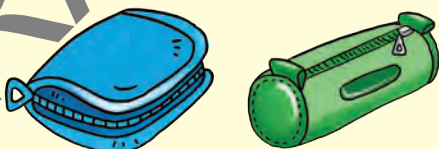

4

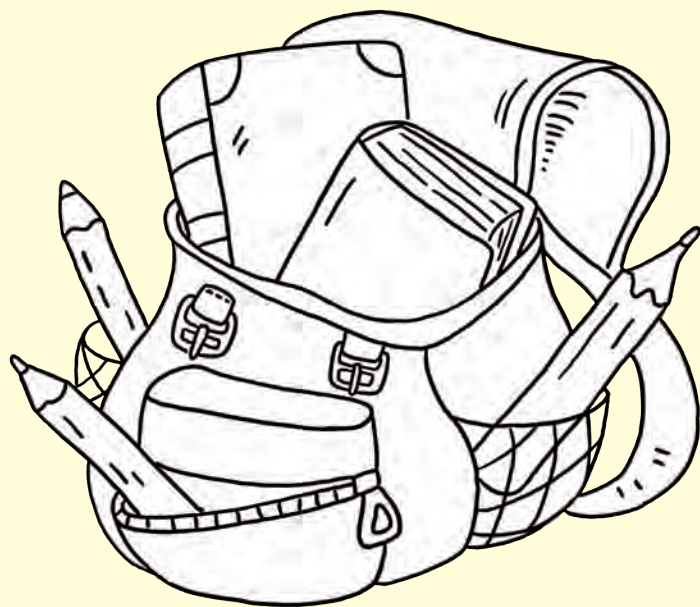

# 2C Forest School

1



2



1



2



3



4



3



1



4



2



5



3



6



4



1



3



2



4



# 2C My Bag

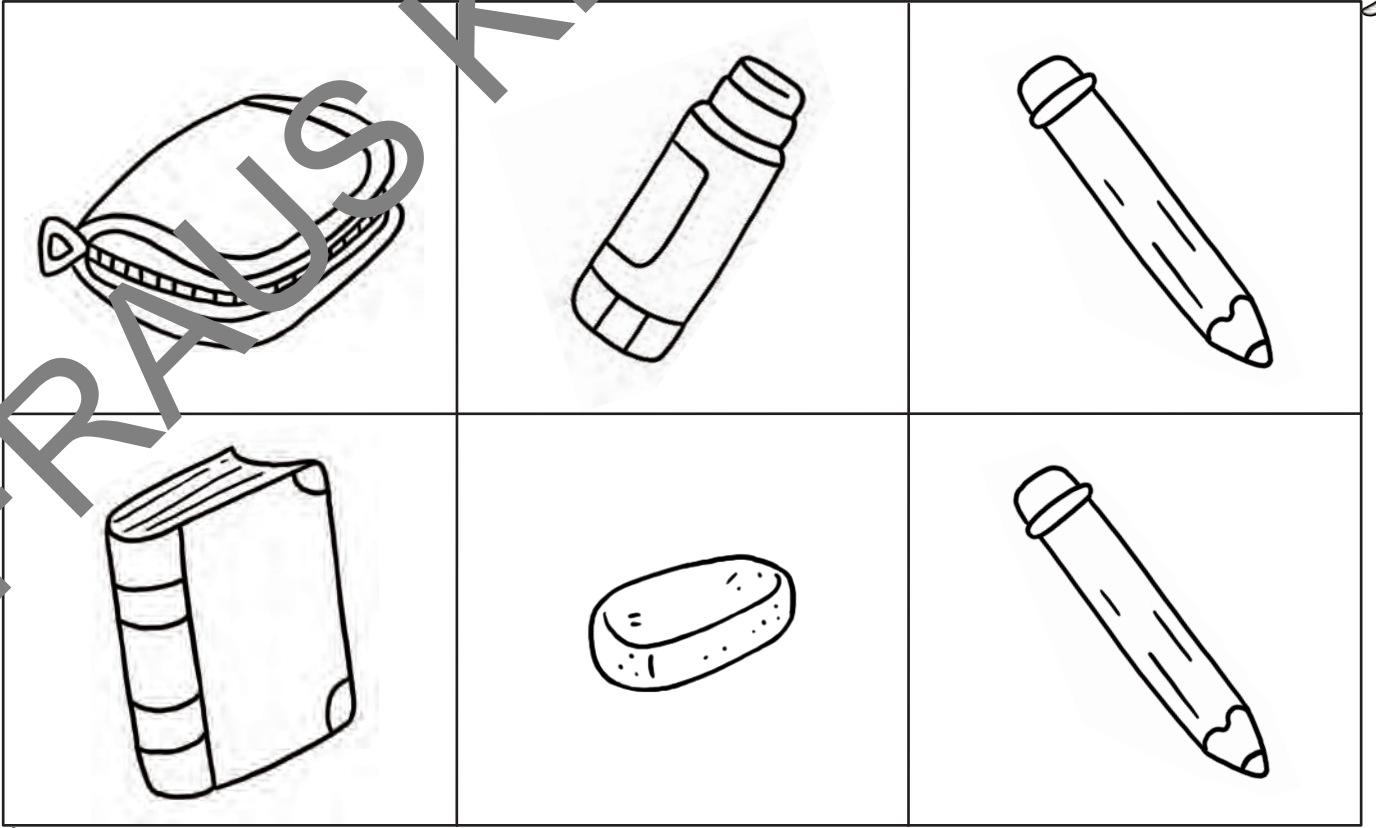
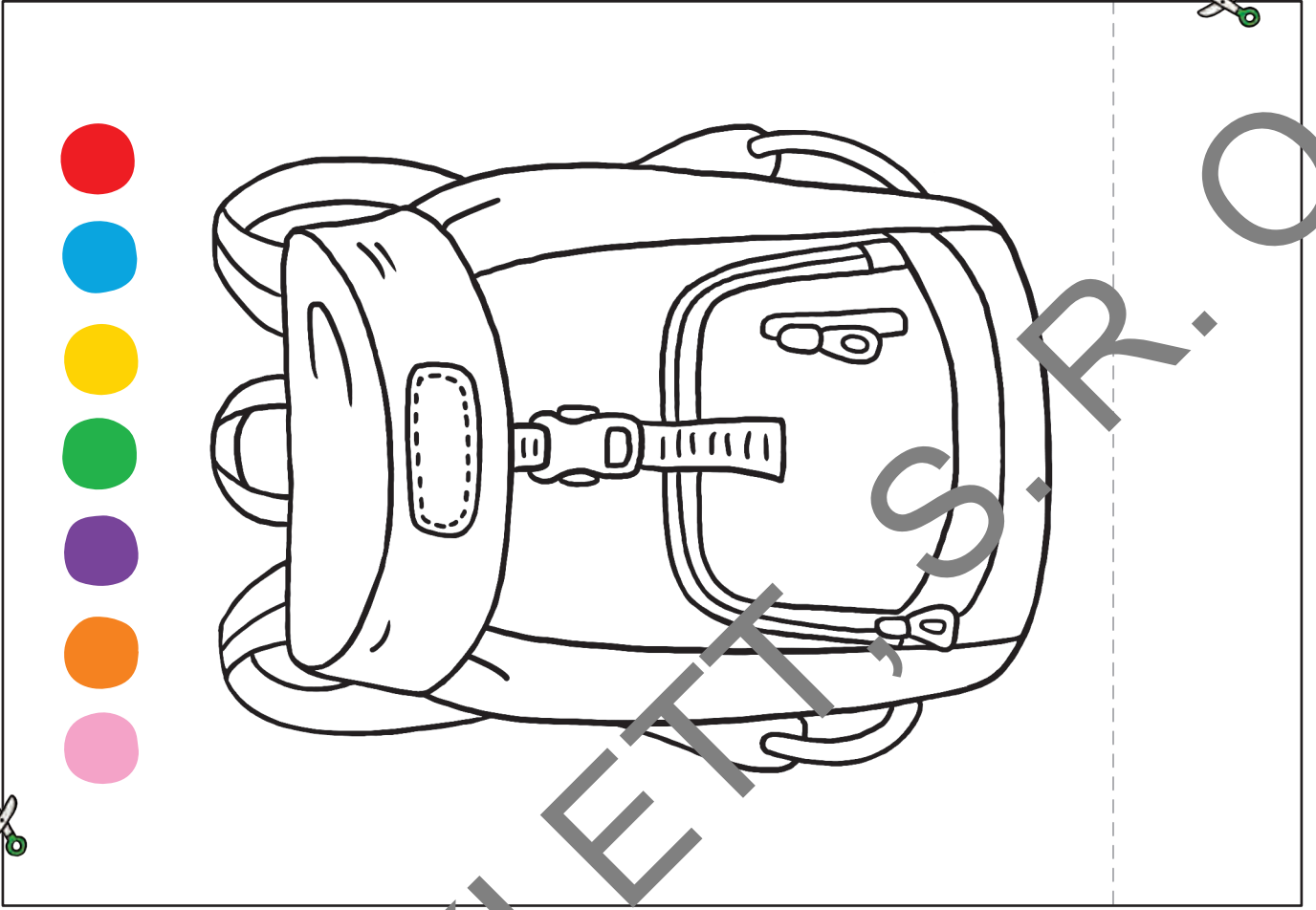

FRAUS KLETT, S.R.O.



FRAUS KLETT, S.R.O.

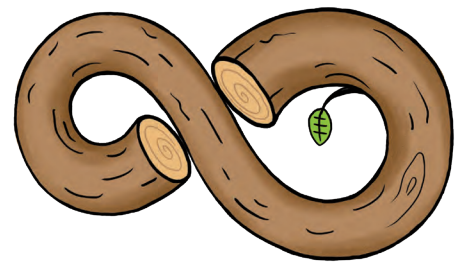
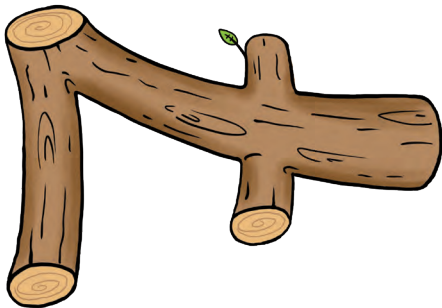
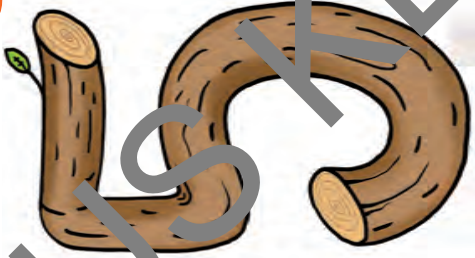
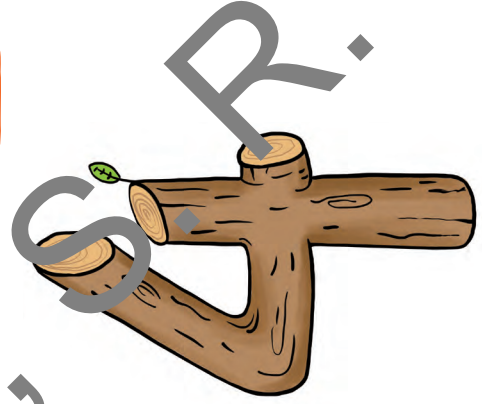
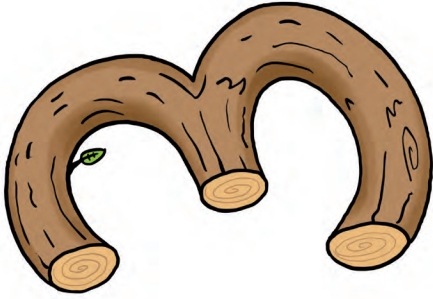
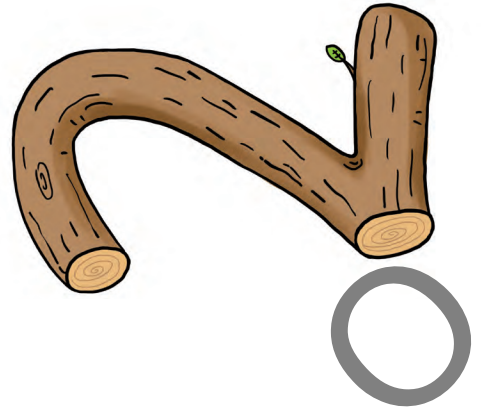
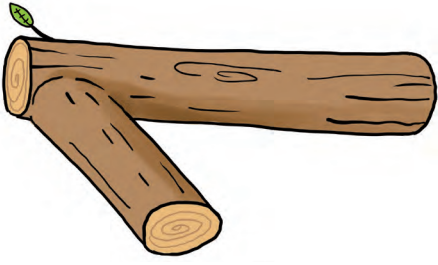

FRAUSKLETT

FRAUS KLETT, S.R.O.

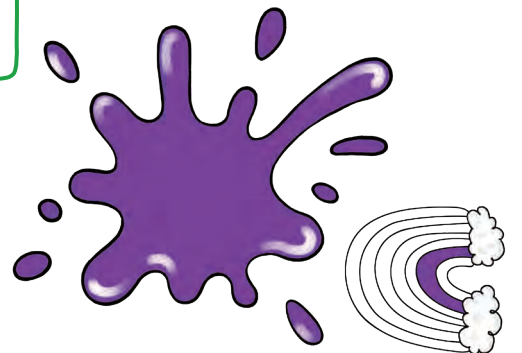
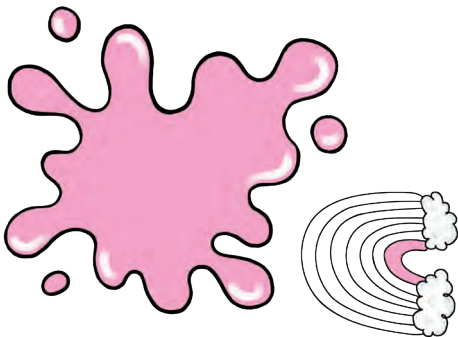
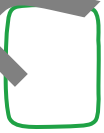
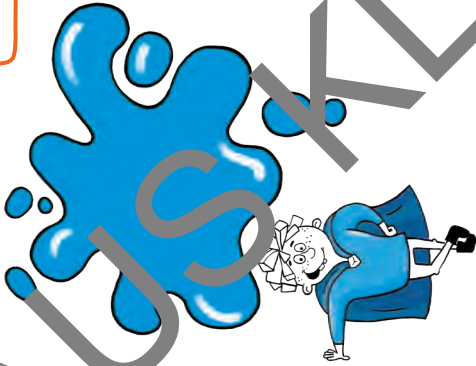
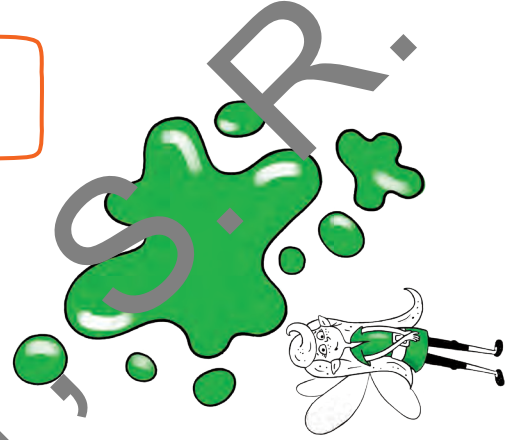
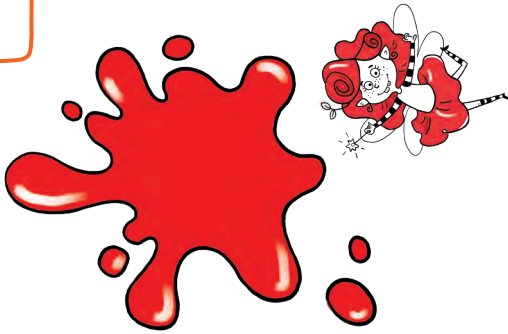
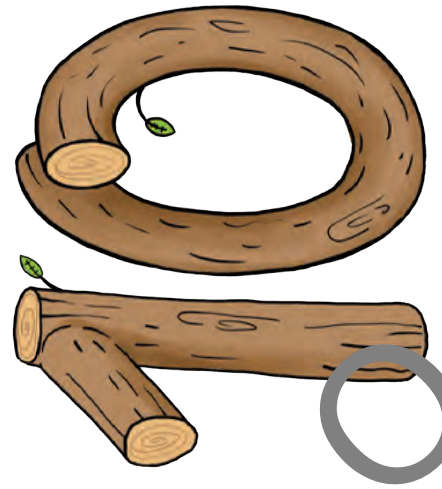
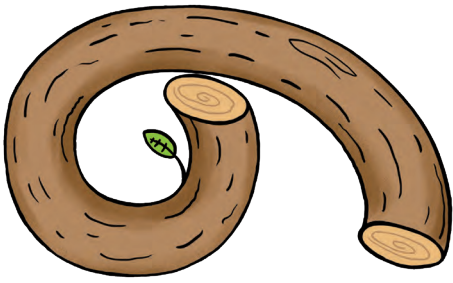

FRÄUSKYLETT

FRAUS KLETT, S.R.O.

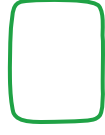
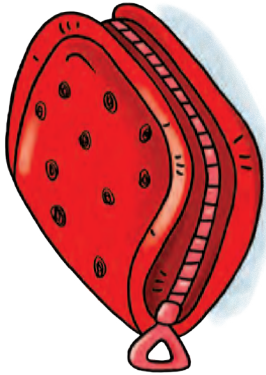
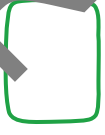
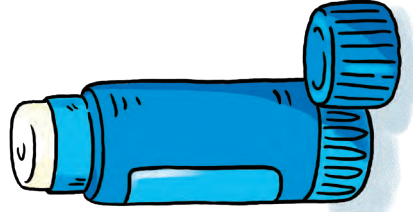
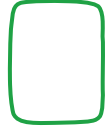
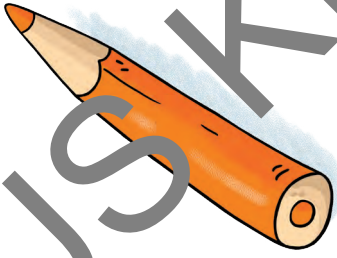
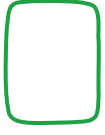
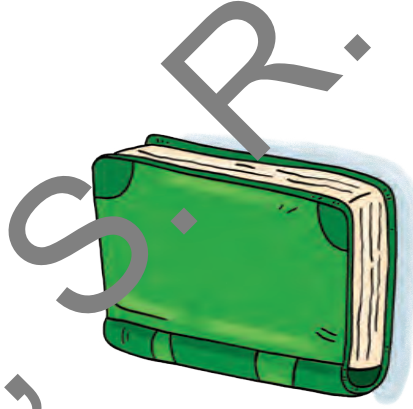
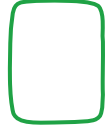
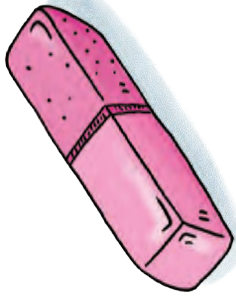
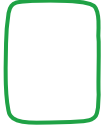
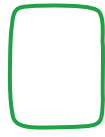
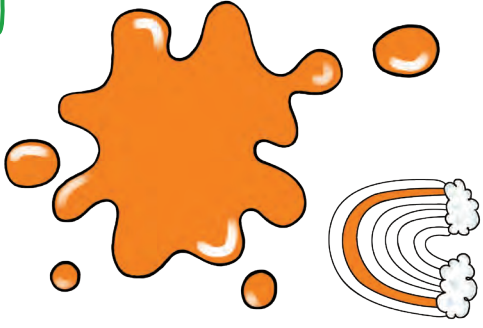
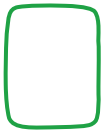

FRAUSKLETT, S.R.

FRAUS KLETT, S.R.O.

# 3A House in the Forest

1  

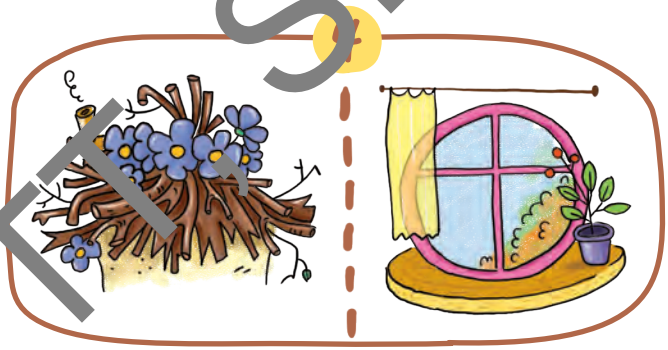
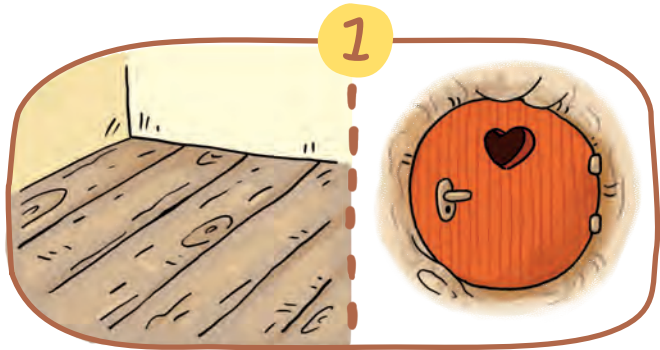

2   



# 3A Extra

3



4



# 3B House in the Forest

1



1



2



3

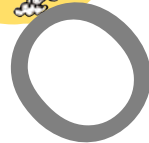

2



1

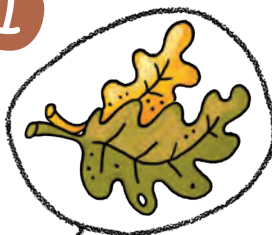

2



3



4



5



# 3B Extra

3

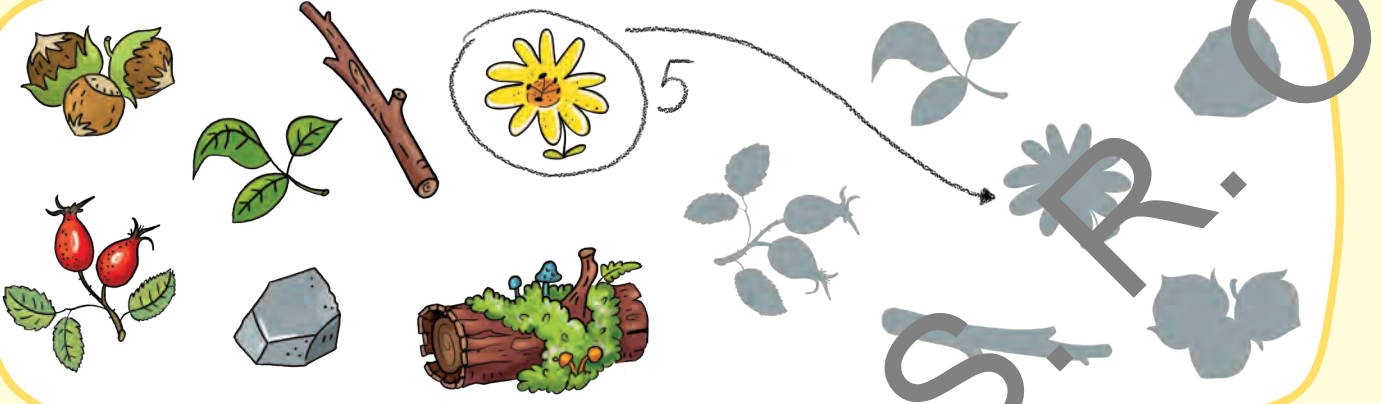

4



# 3C House in the Forest

1   



- 
- 
- 
- 
- 
- 
- 

2   

- 
- 
- 
- 

- 
- 
- 
- 
- 

# 3C Extra

3





4

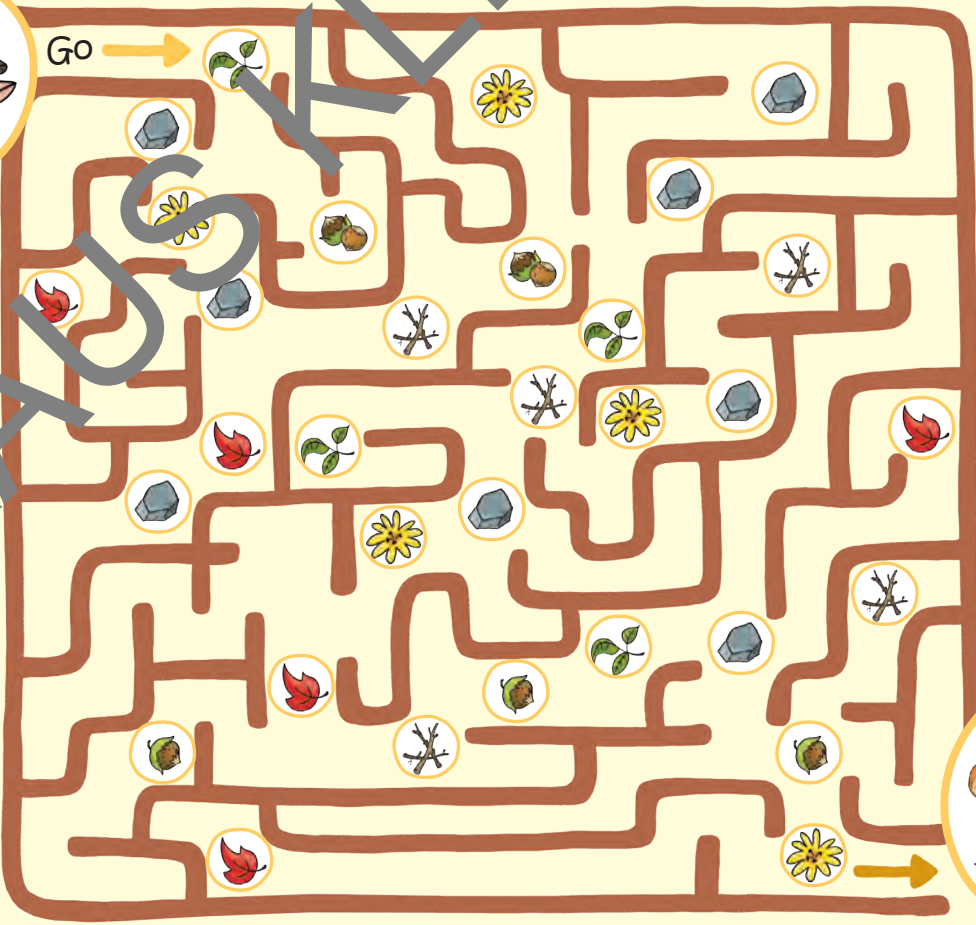

- 
- 
- 
- 
- 
- 
- 
- 
- 
- 
- 

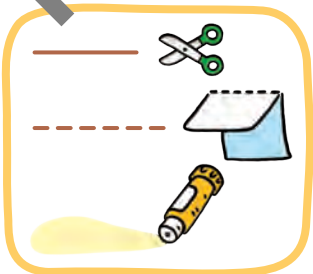
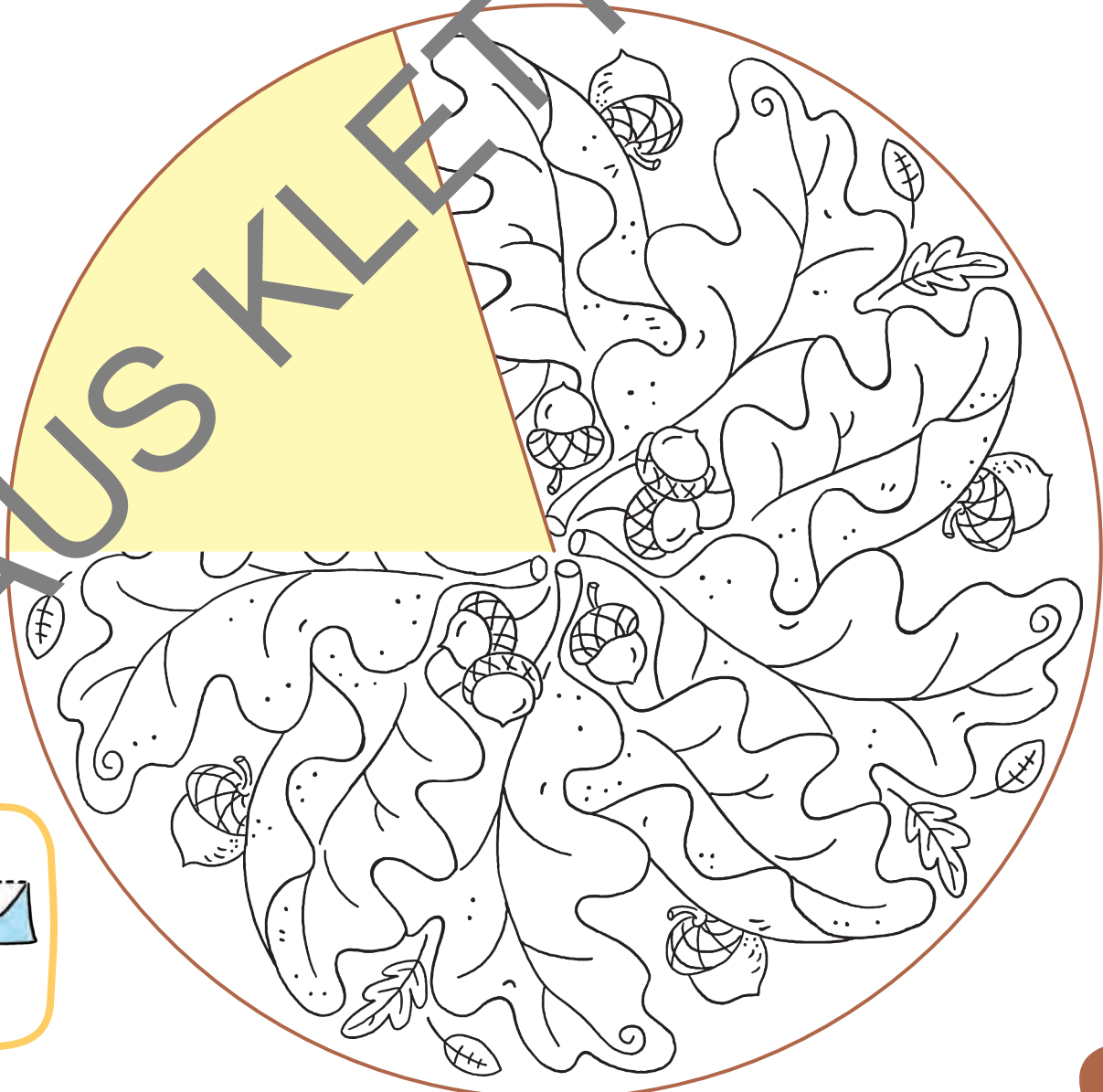
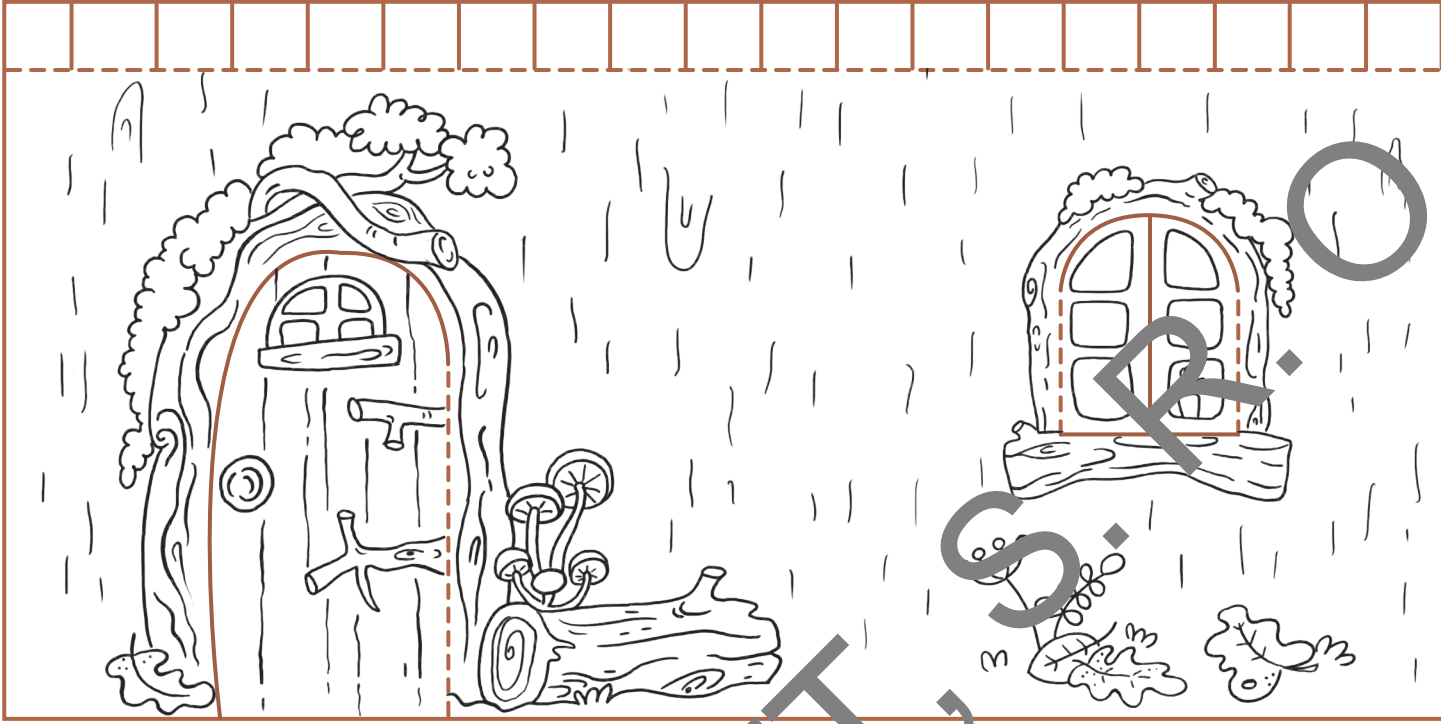

# 3C My House





FRAUS KLETT, S.R.O.

# 3D Let's build a house!

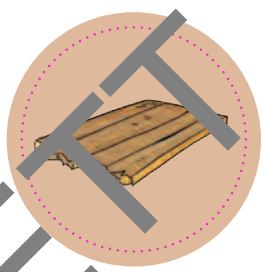
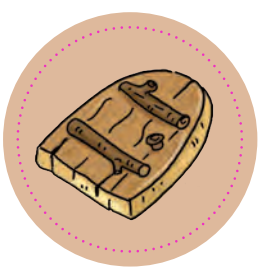
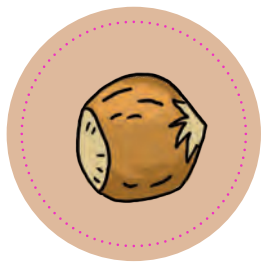
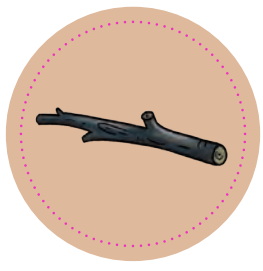

S. R. O.



FRAUS KLETT, S.R.O.

# 4A Toys and Games

1



2



# 4A Extra

3



1



2



3



4



5



6



4



2



3



1



4



6



5



# 4B Toys and Games

1

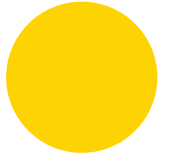
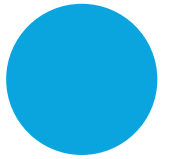
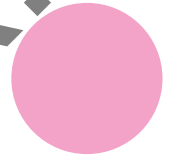
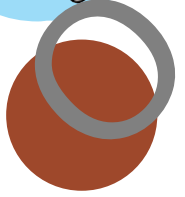
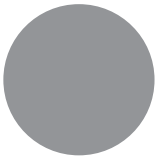
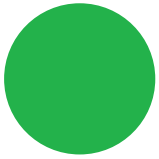

2



1

3

2

4



# 4B Extra

3



1



2



3



4



4



1

2

3

4

5

6

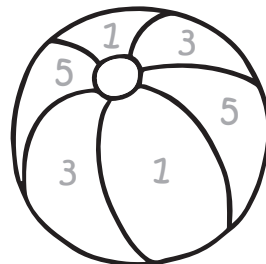
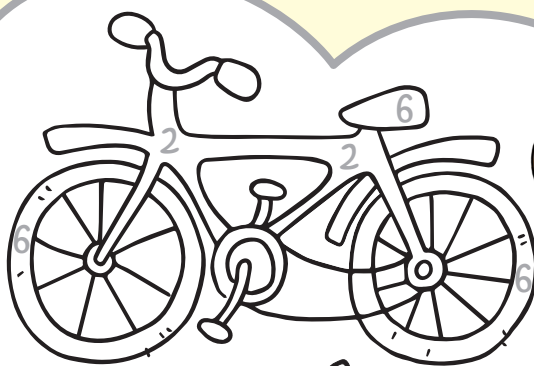
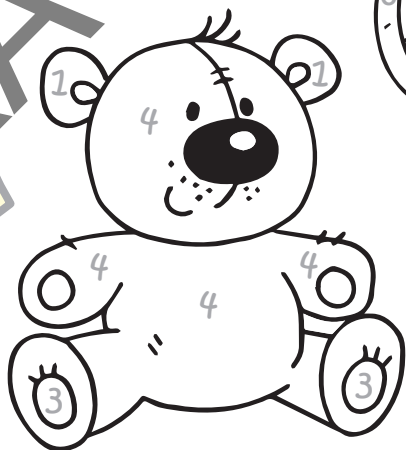

# 4C Toys and Games

1



2



- 1
- 2
- 3
- 4
- 5
- 6

3



1



2



3



4



5



1



# 4C Spinners

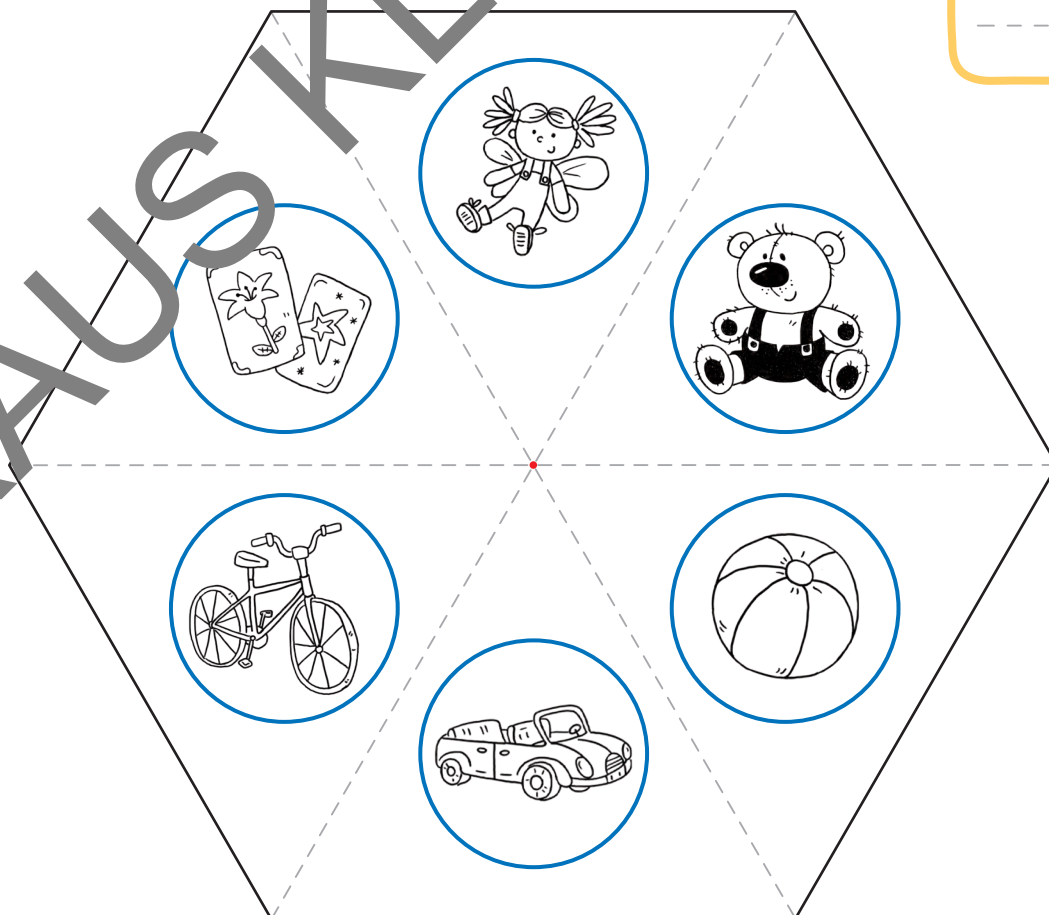
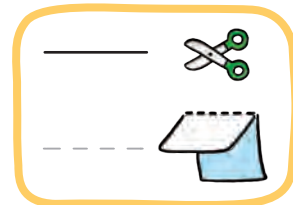
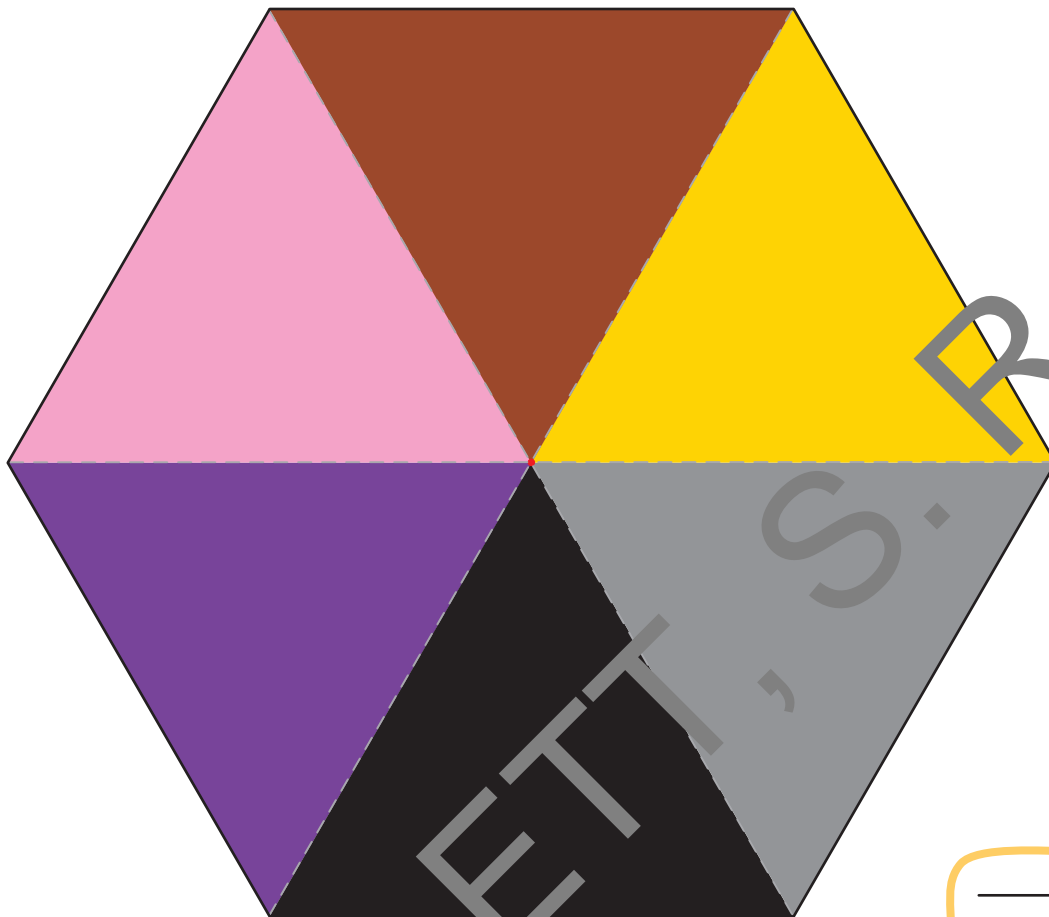

FRAUS KLETT, S.R.O.



# 4D Quartets





# 4D Quartets



Black dot





Red dot



Yellow dot



Purple dot



Pink dot

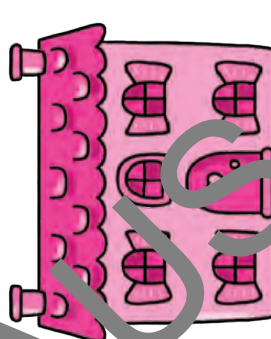

Brown dot

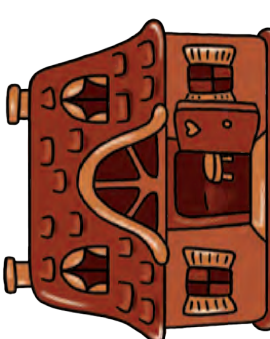

Green dot

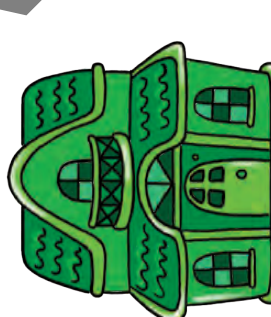

Black dot





# 4D Quartets

FRAUS KLETT, S.R.O.

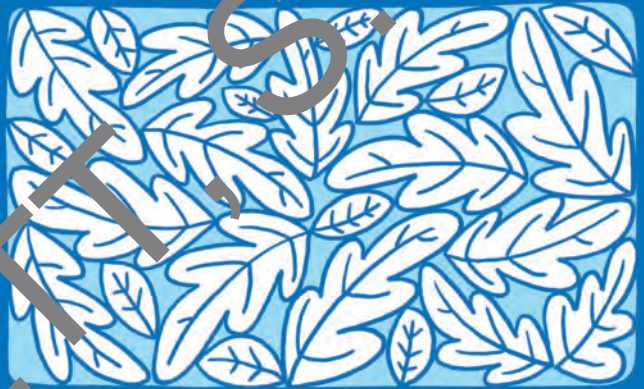

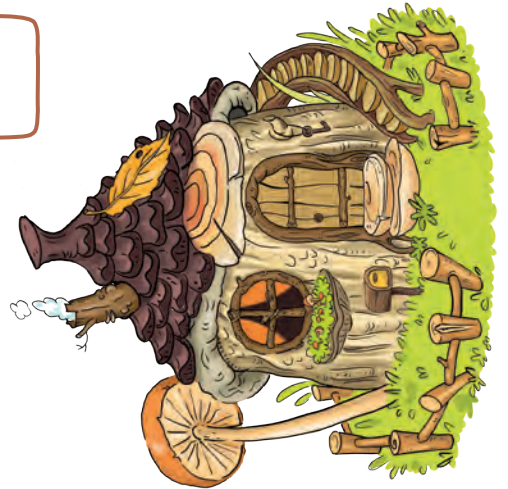
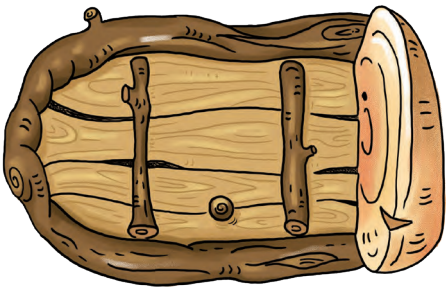
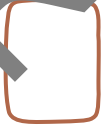
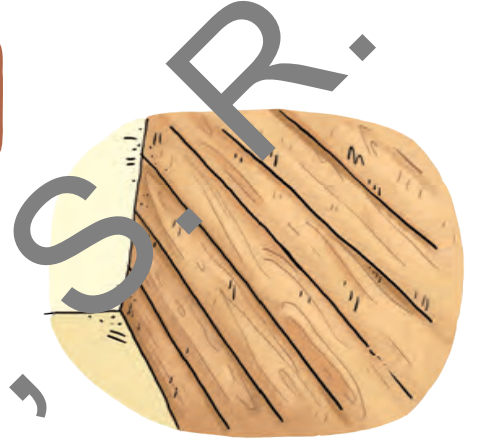
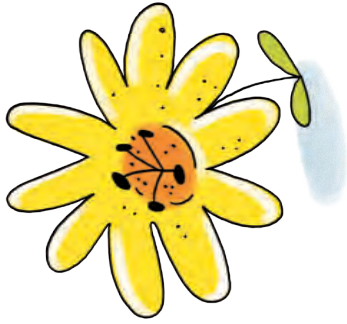
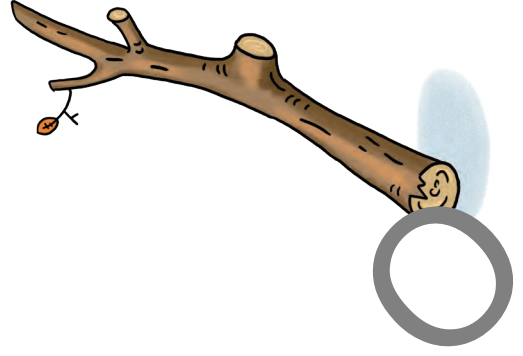
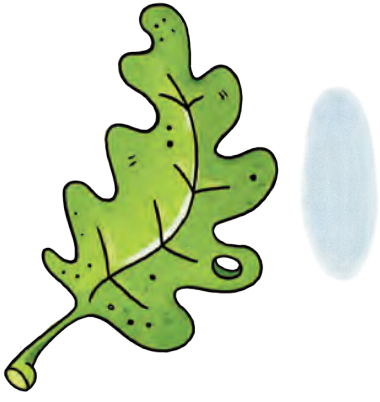
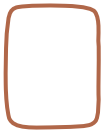

FRAUSKLETT, S.R.

FRAUS KLETT, S.R.O.

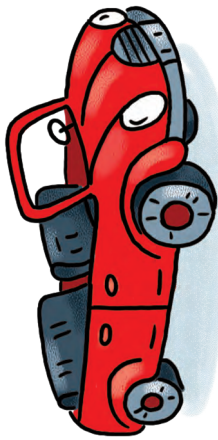
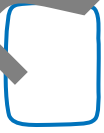
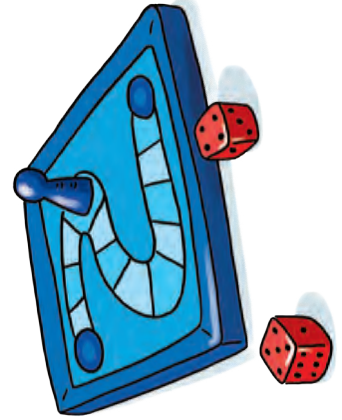
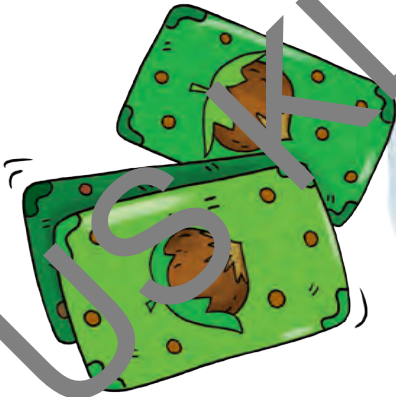
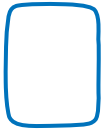
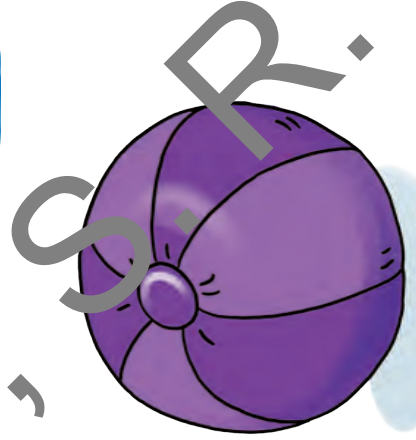
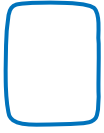
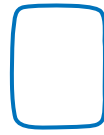
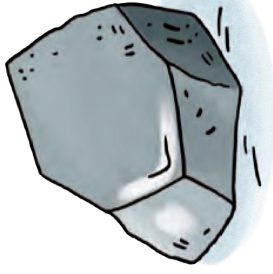

FRANSKALLET, S.R.

FRAUS KLETT, S.R.O.

# 5A Birthday Party and Family

1   

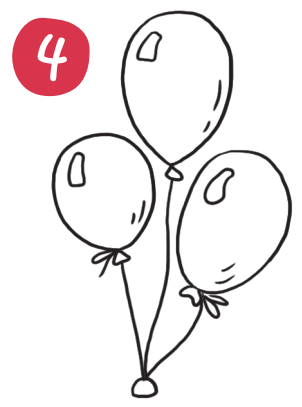

2   

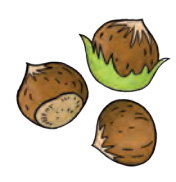
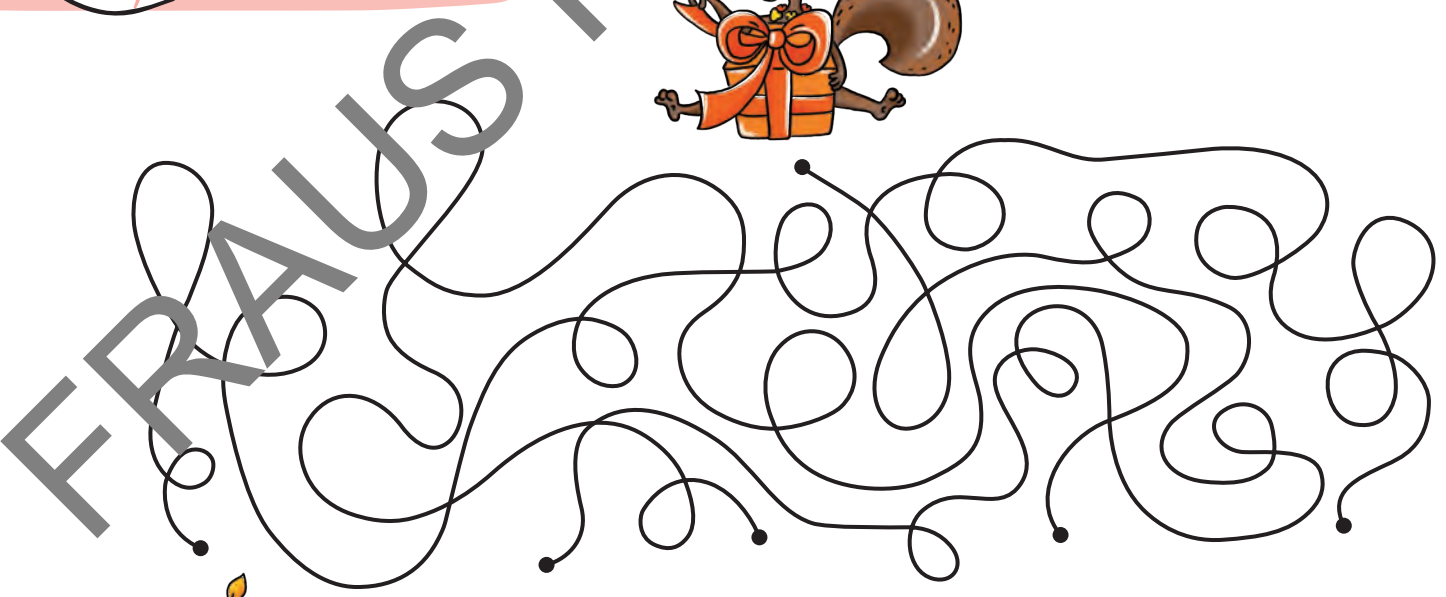

# 5A Extra

3



4



6



8



10



7

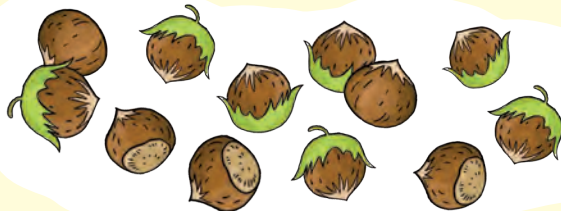

9

# 5B Birthday Party and Family

1



2



1



# 5B Extra

3

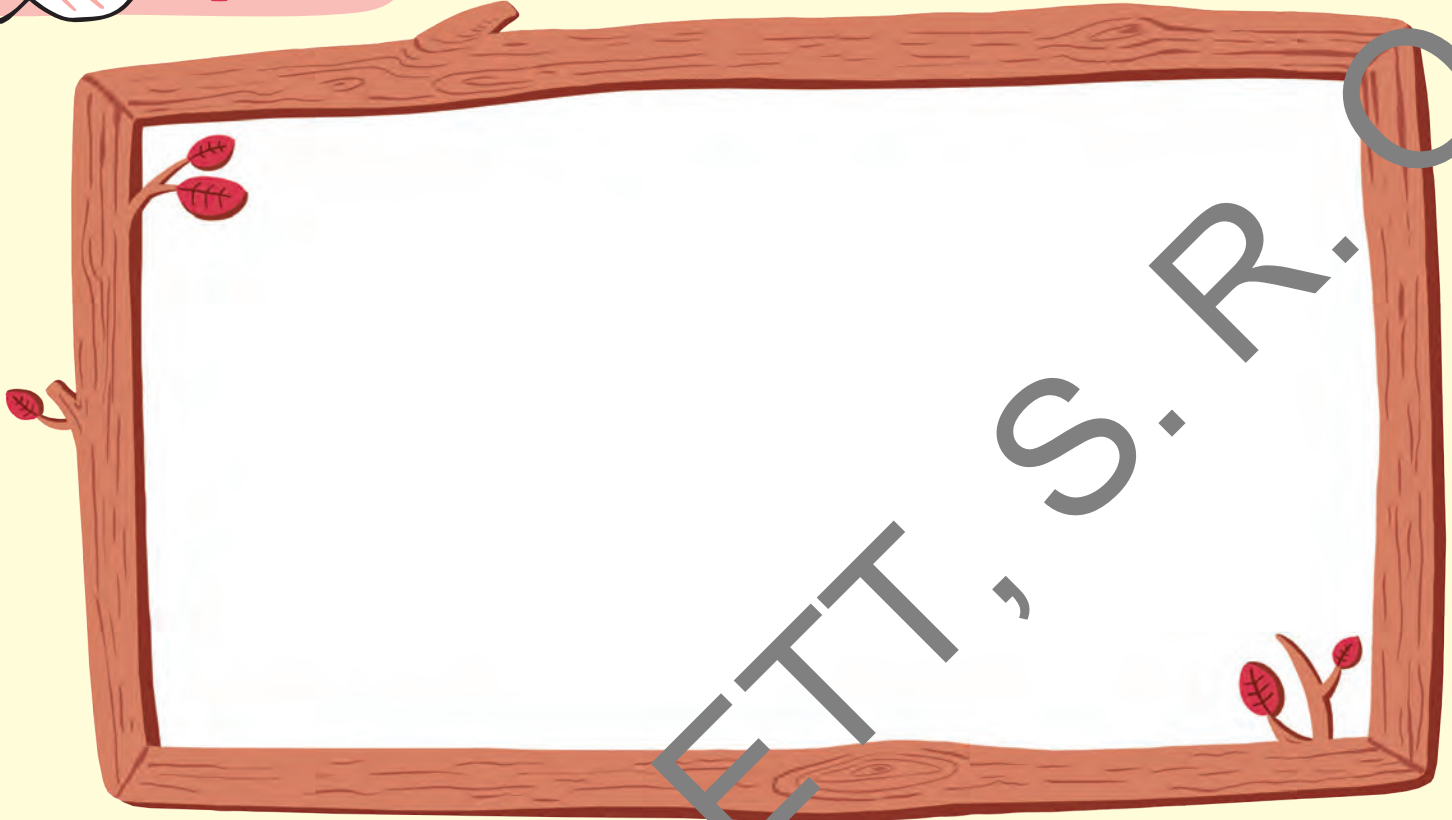

4

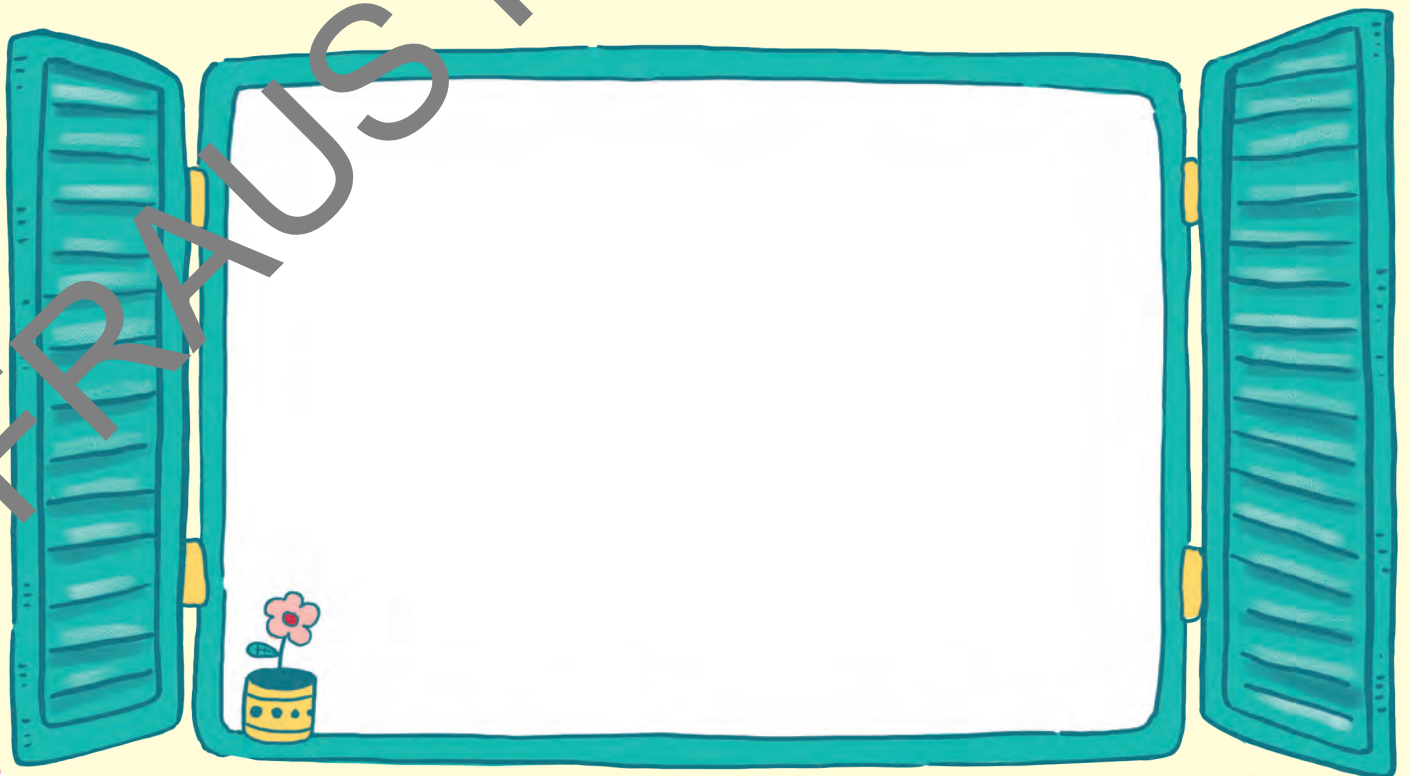

# 5B My Family

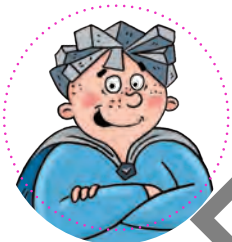

FRAUS KLETT S.R.O.

FRAUS KLETT, S.R.O.

# 5C Birthday Party and Family

1   



1



2



3



4



5

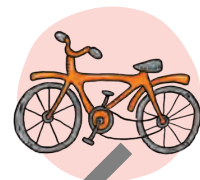

2  

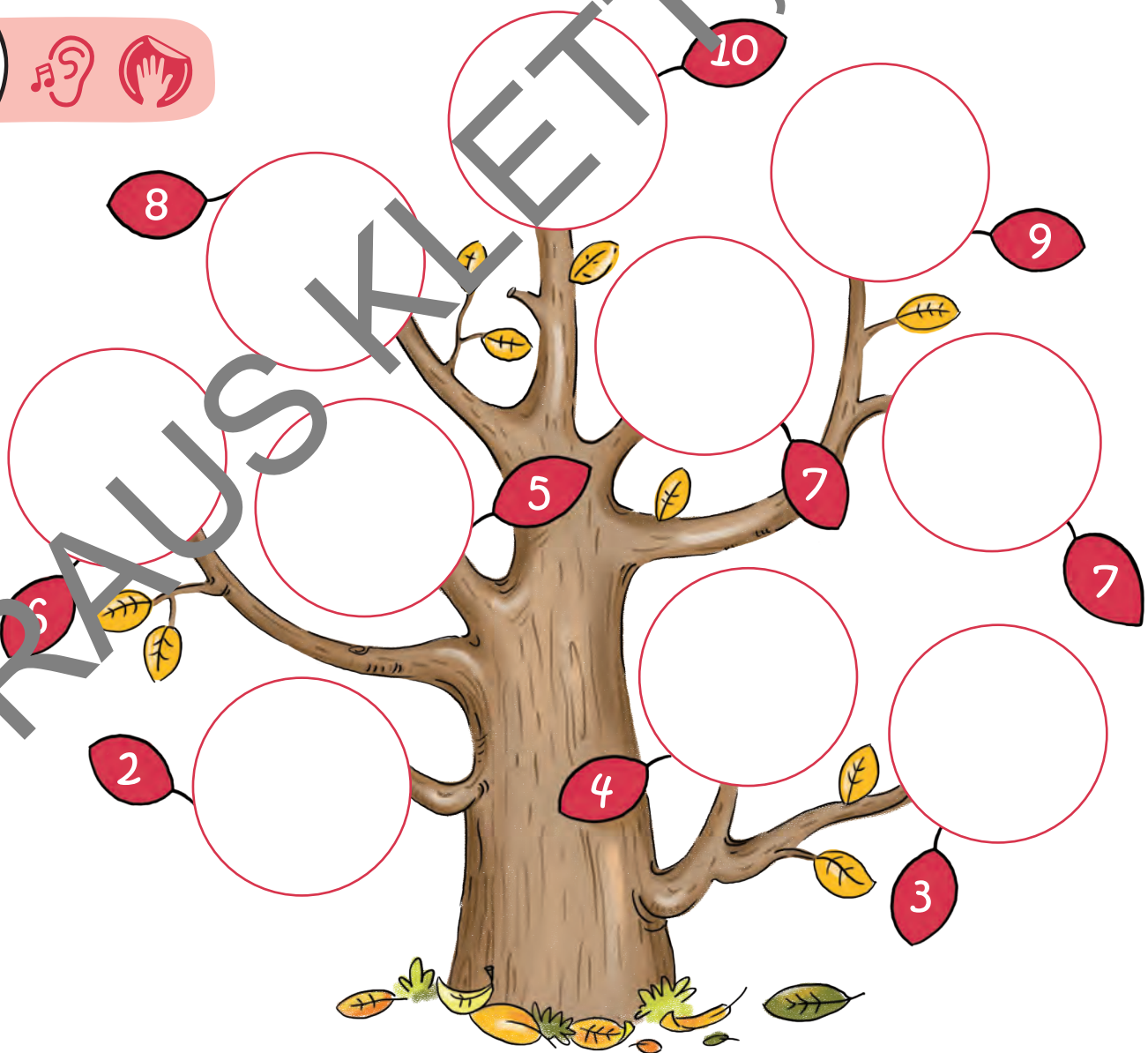

# 5C Extra

3



1



2



3



4



5



4



$$\begin{array}{c}
 \text{3 gifts} \\
 + \\
 \text{3 gifts} \\
 \hline
 \square
 \end{array}$$

$$\begin{array}{c}
 \text{4 flowers} \\
 + \\
 \text{4 flowers} \\
 \hline
 \square
 \end{array}$$

$$\begin{array}{c}
 \text{6 balloons} \\
 + \\
 \text{2 balloons} \\
 \hline
 \square
 \end{array}$$

$$\begin{array}{c}
 \text{6 cupcakes} \\
 + \\
 \text{6 cupcakes} \\
 \hline
 \square
 \end{array}$$

$$\begin{array}{c}
 \text{4 nuts} \\
 + \\
 \text{4 nuts} \\
 \hline
 \square
 \end{array}$$

$$1 + 2 = \square$$

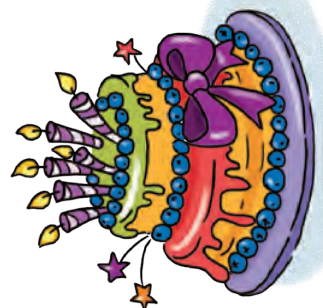
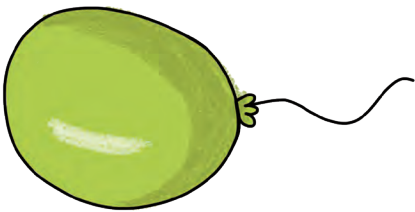
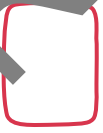

FRASUSKLETT

S. R. O.

FRAUS KLETT, S.R.O.

# 5C+D Box for Mini FC



FRAUS KLETT, S.R.O.

# 6A My Body

1



2



# 6A Extra

3



4

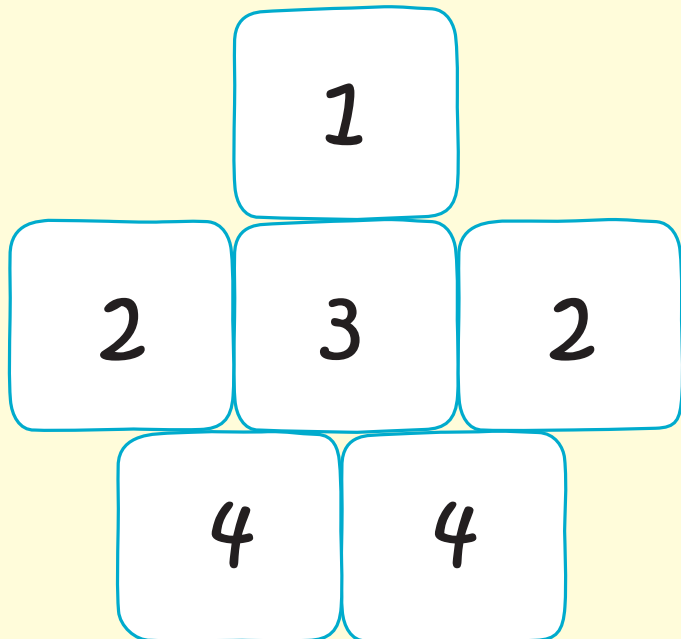
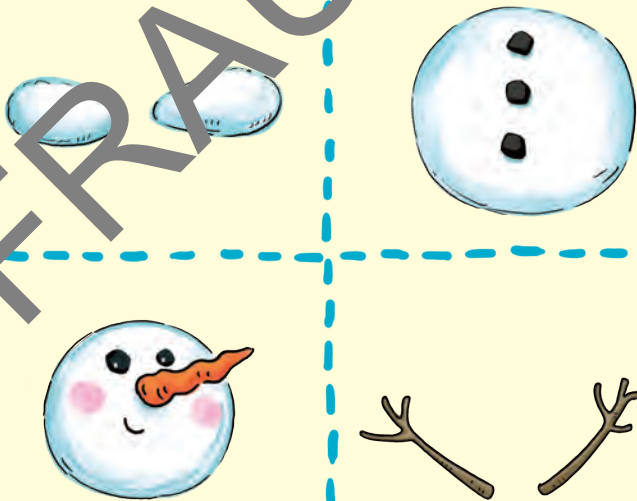

# 6B My Body

1  

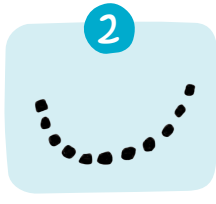
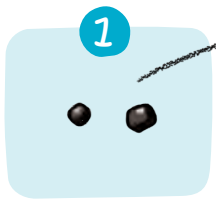

2  



# 6B Extra

3

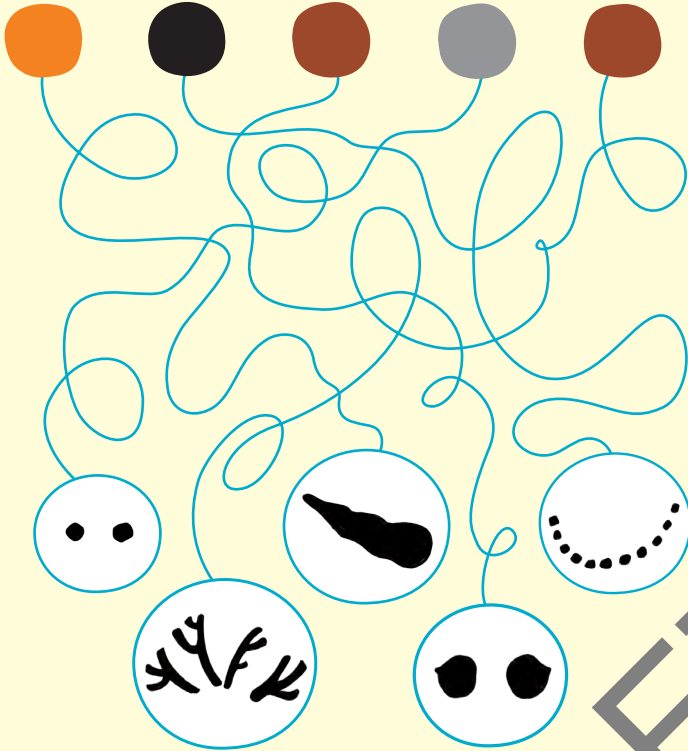

4



# 6C My Body

1



2



# 6C Extra

3



1



2



3



4



4

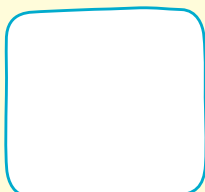
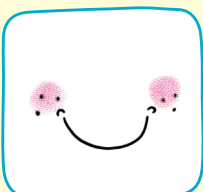
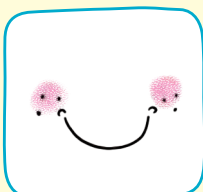

# 6 Mini Flashcards

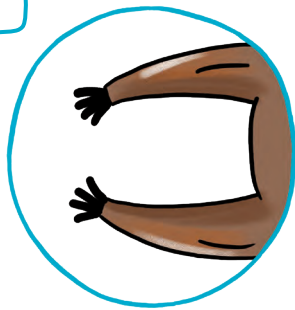
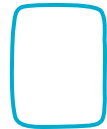
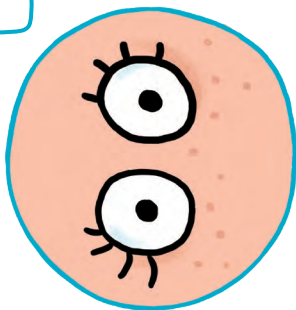
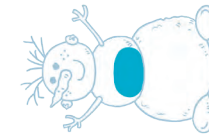
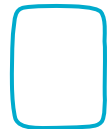
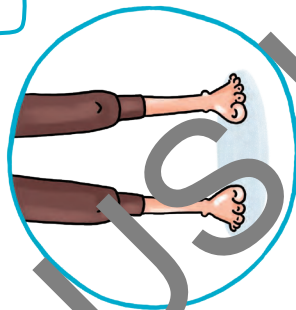
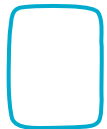
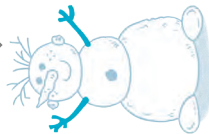
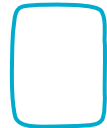
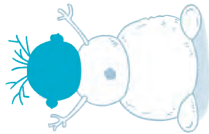
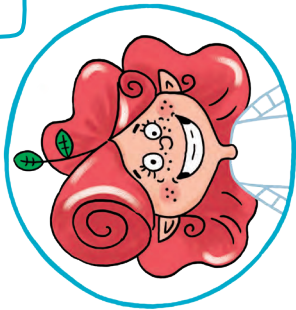
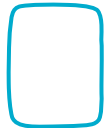

O

R

SKLETT

FRAS

FRAUS KLETT, S.R.O.

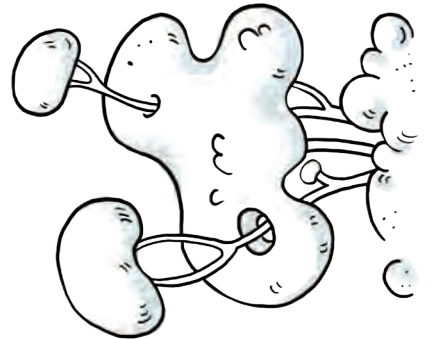
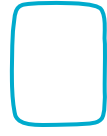
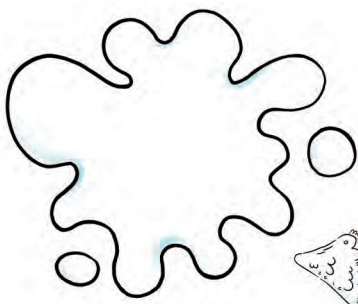
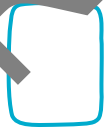
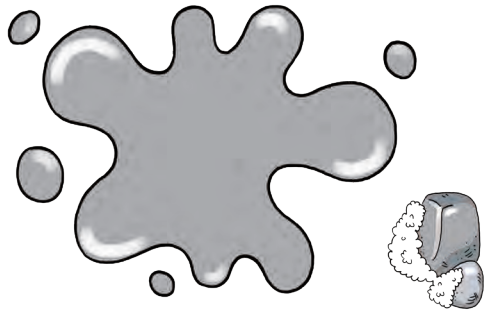
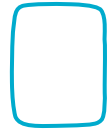
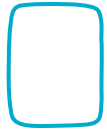
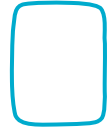
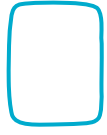
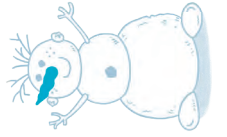
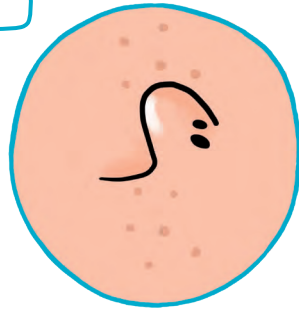
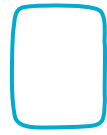
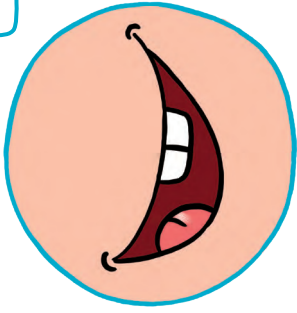
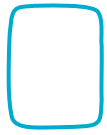

O

S R

FRASST KLETT

FRAUS KLETT, S.R.O.

# 6D Make your Elf



FRAUS KLETT, S.R.O.

# 6D Make your Elf

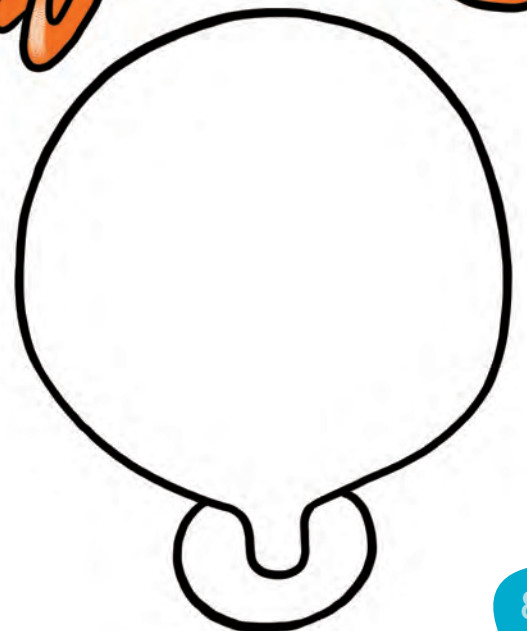
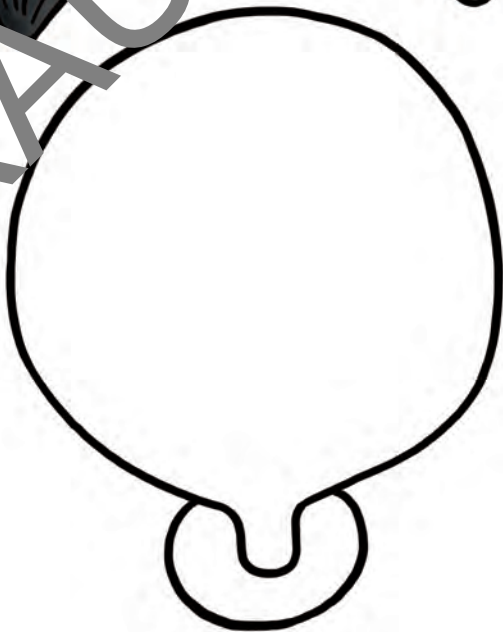
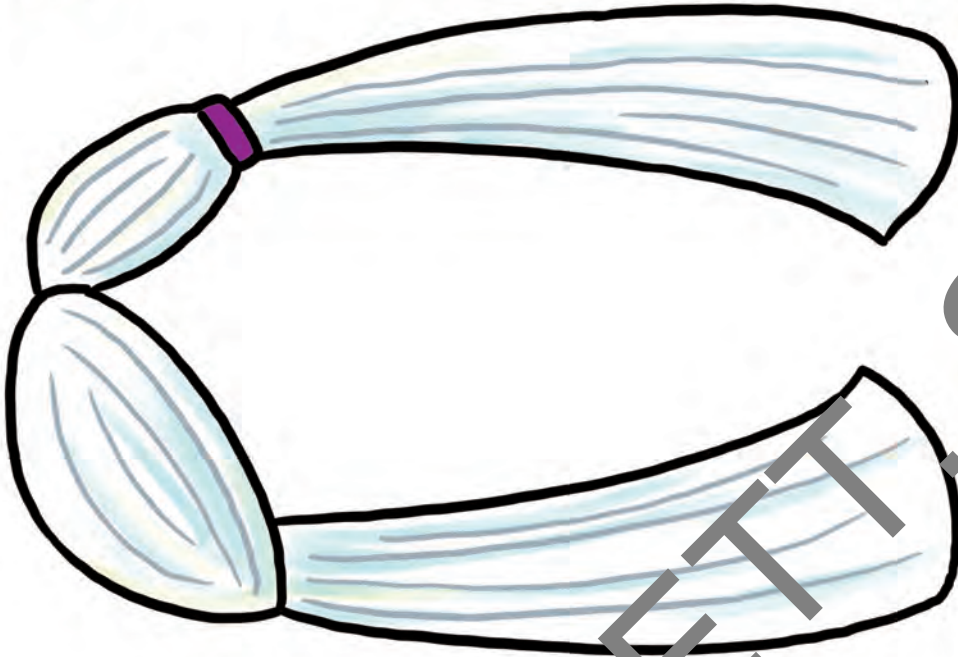

FRAUS KLETT, S.R.O.

# 7A Animals & Pets

1



1



2



# 7A Extra

3

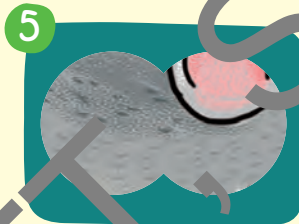

4



- 1
- 2
- 3
- 4
- 5
- 6
- 7
- 8

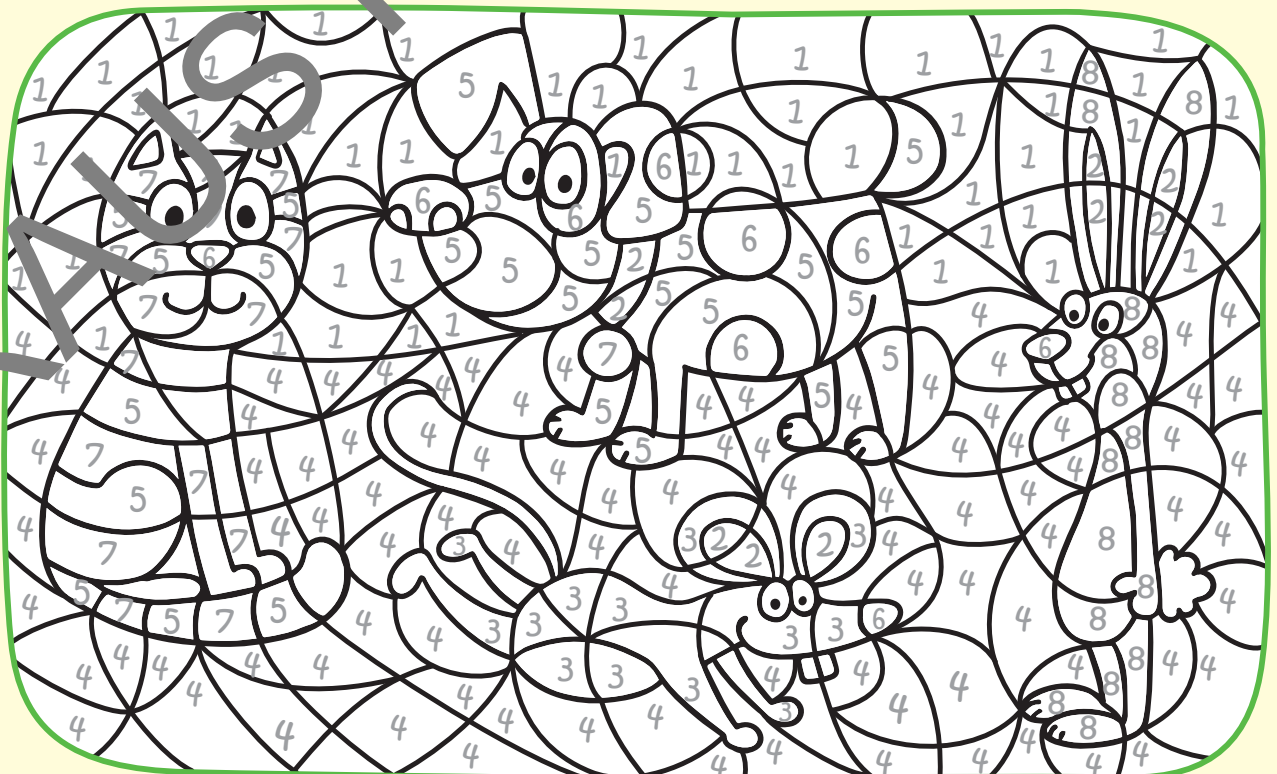

# 7B Animals & Pets

1



2

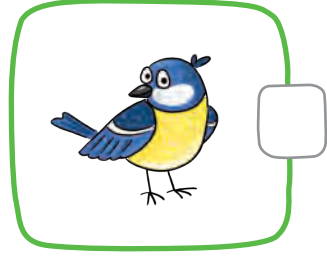
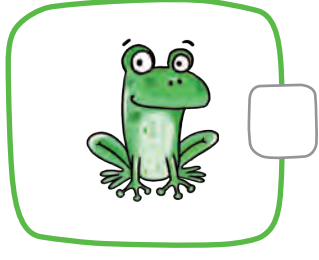
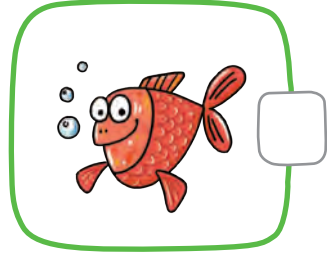
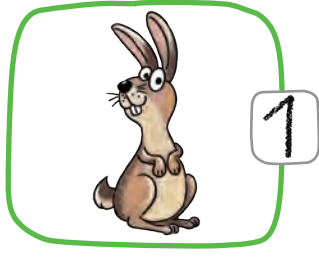
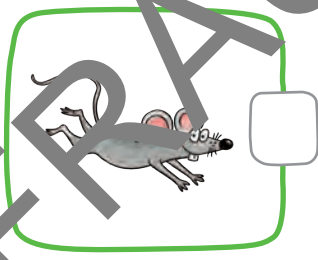

# 7B Extra

3

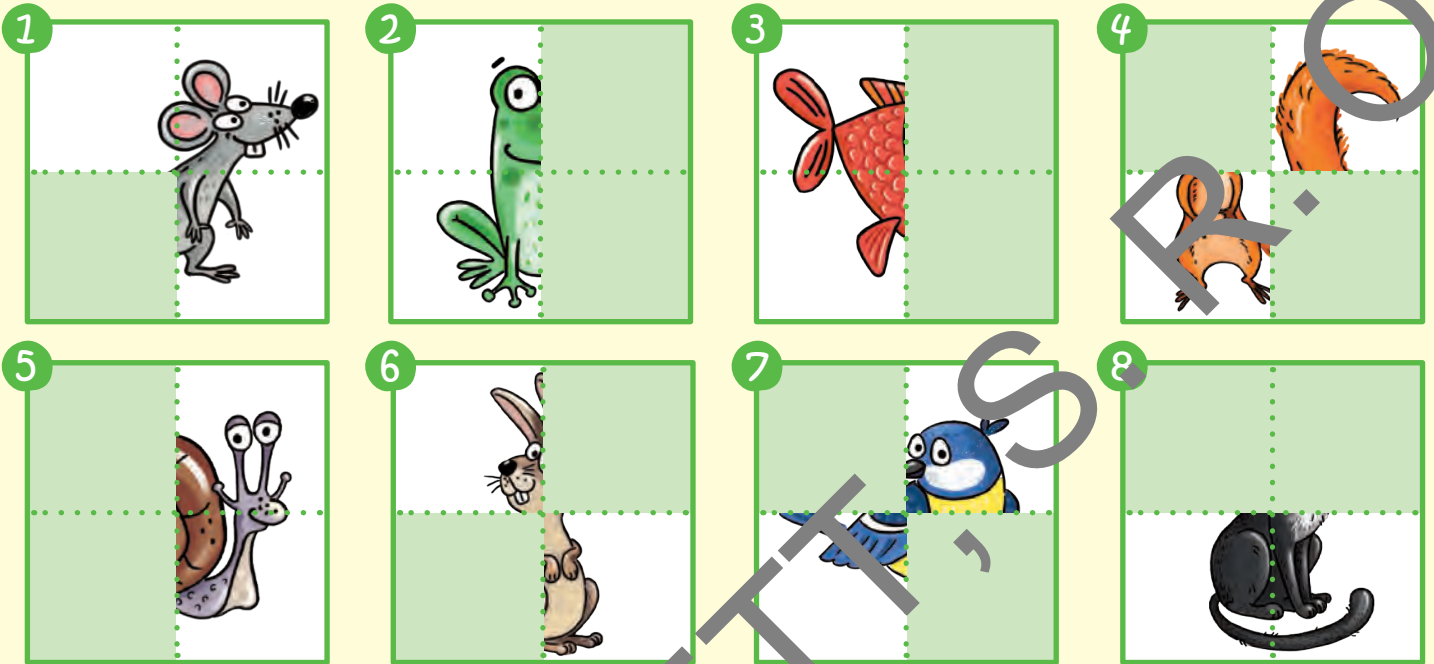

4

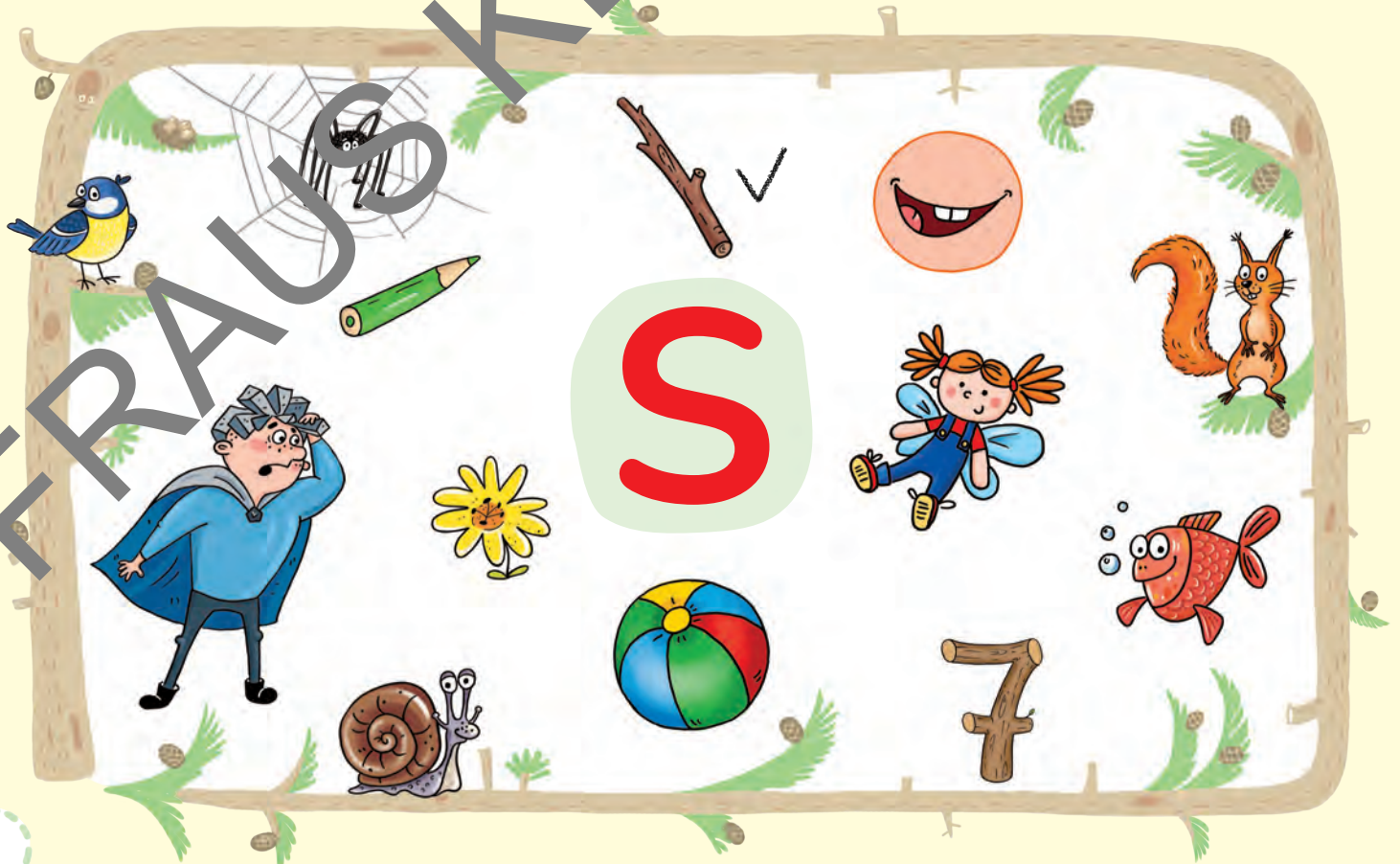

# 7C Animals & Pets

1

1

2

3

4

5

6

7

8

2



3



5

4



3

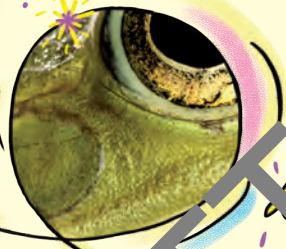

2

1

4

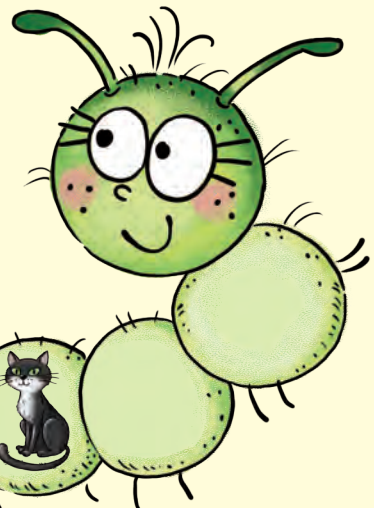
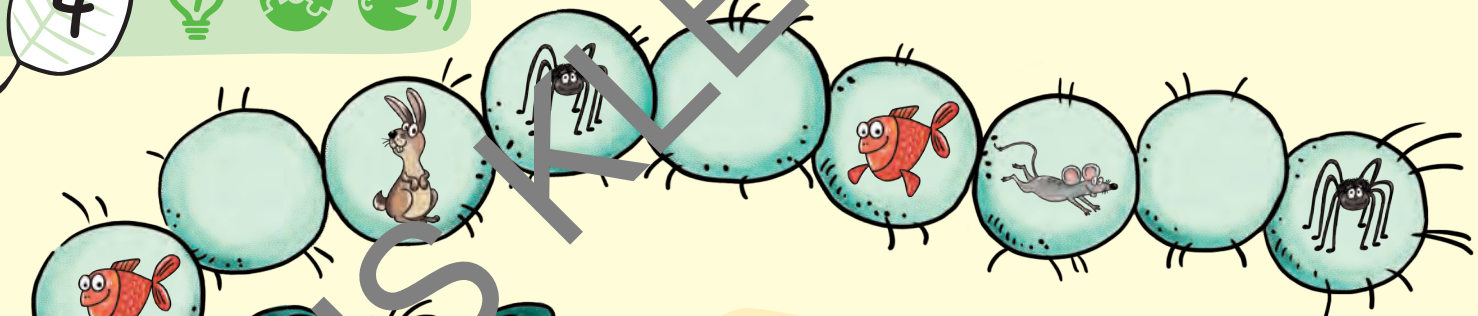

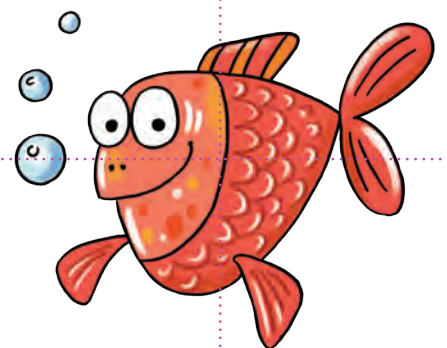
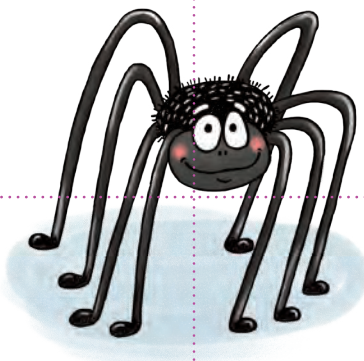
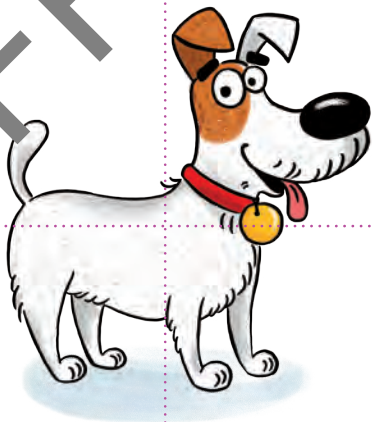
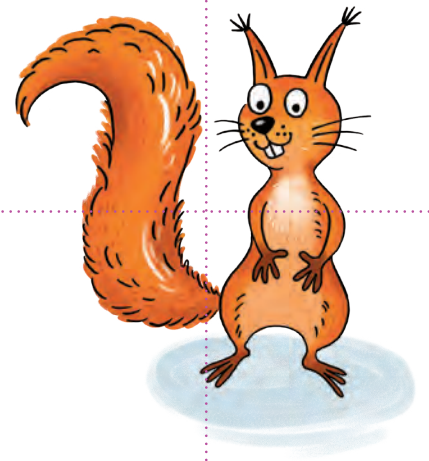
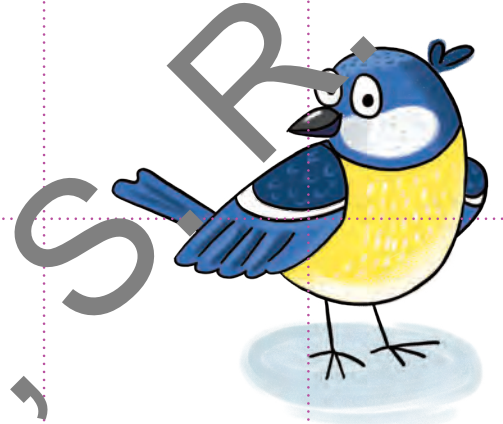
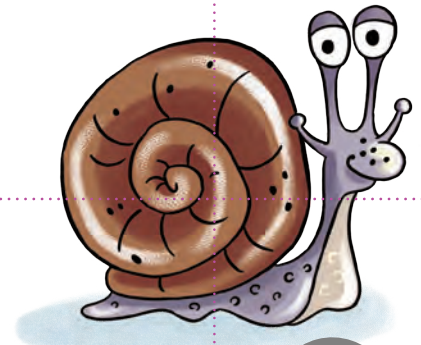
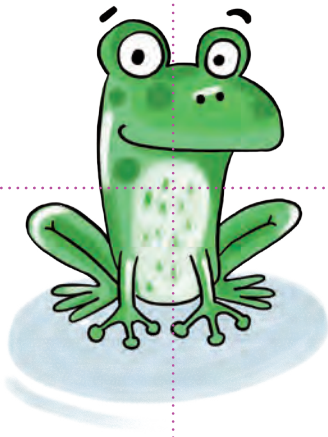
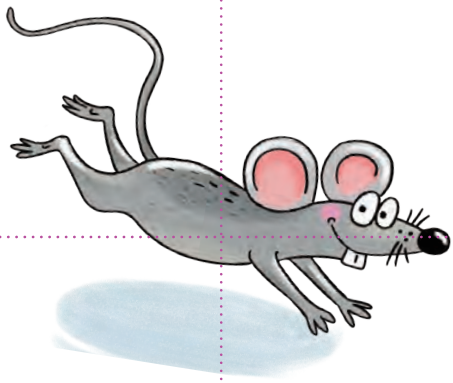

FRAUS KLETT, S R O.

FRAUS KLETT, S.R.O.

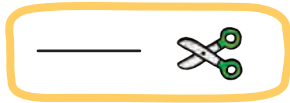

FRAUS KLETT, S.R.O.

FRAUS KLETT, S.R.O.

# A Walk in the Forest

1



0



1



2



3



4



5



2



1

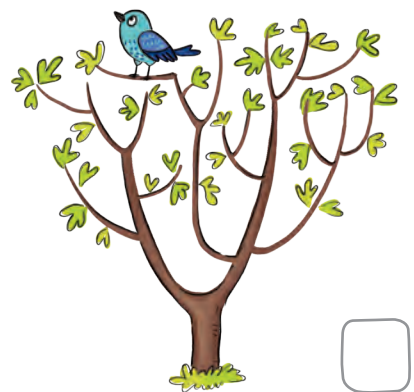
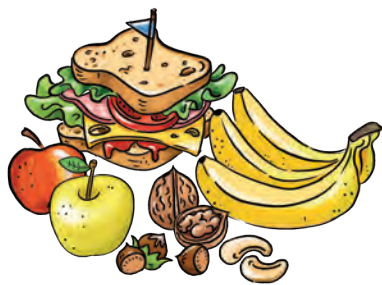

3



1



2



3



4



5

4



# 8B Walk in the Forest

1



			X		✓		

2



3

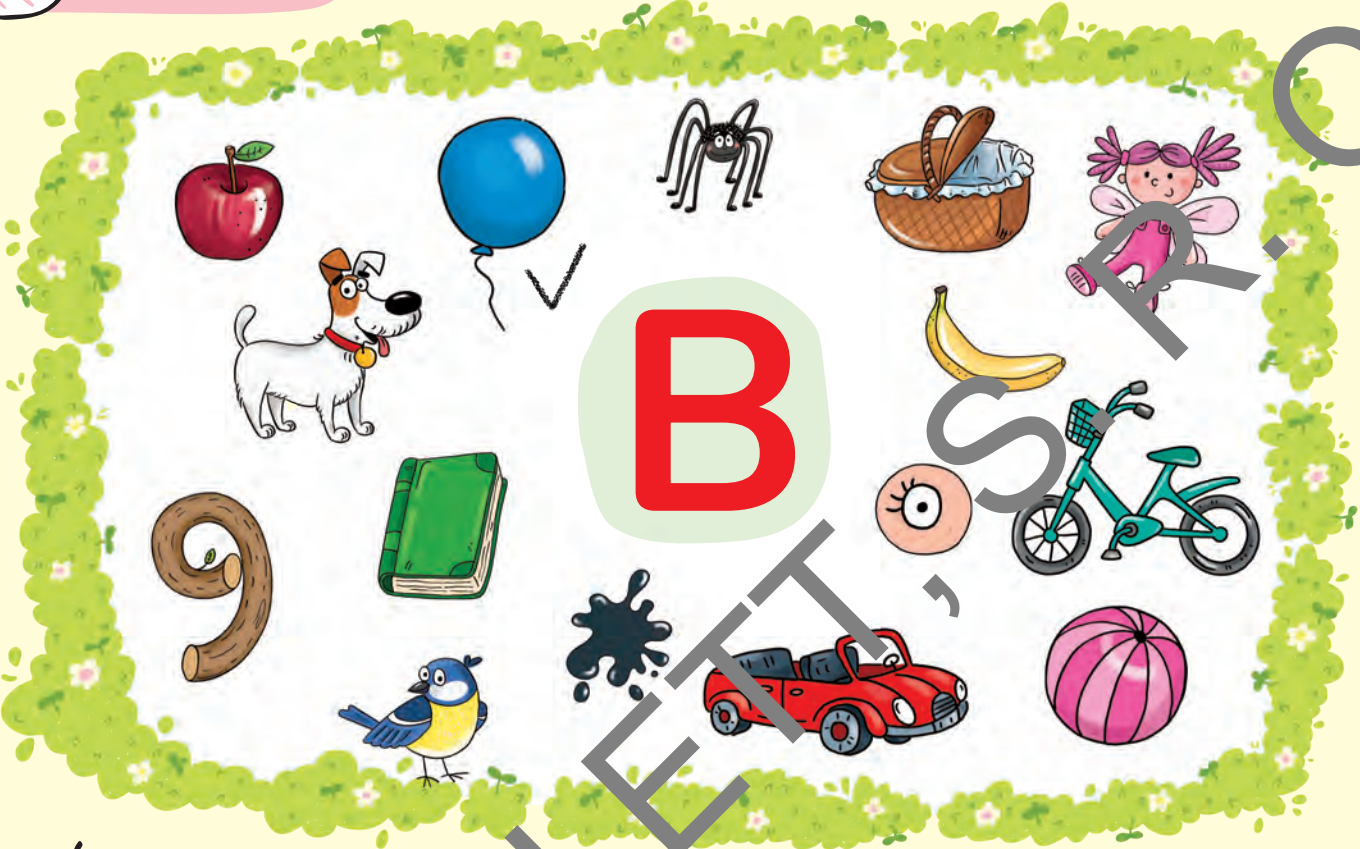

4



# 8C Walk in the Forest

1   



2  



3



1



2



3



4



1



2



3



4



5



6





5

4

3

2

1



O

FRAUS KLETT, S. R.

FRAUS KLETT, S. R.

FRAUS KLETT, S. R.

FRAUS KLETT, S.R.O.

# 8C, Smiley Sticks



## Extra 2, Christmas Tree

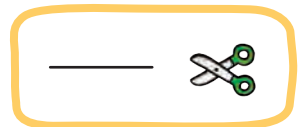
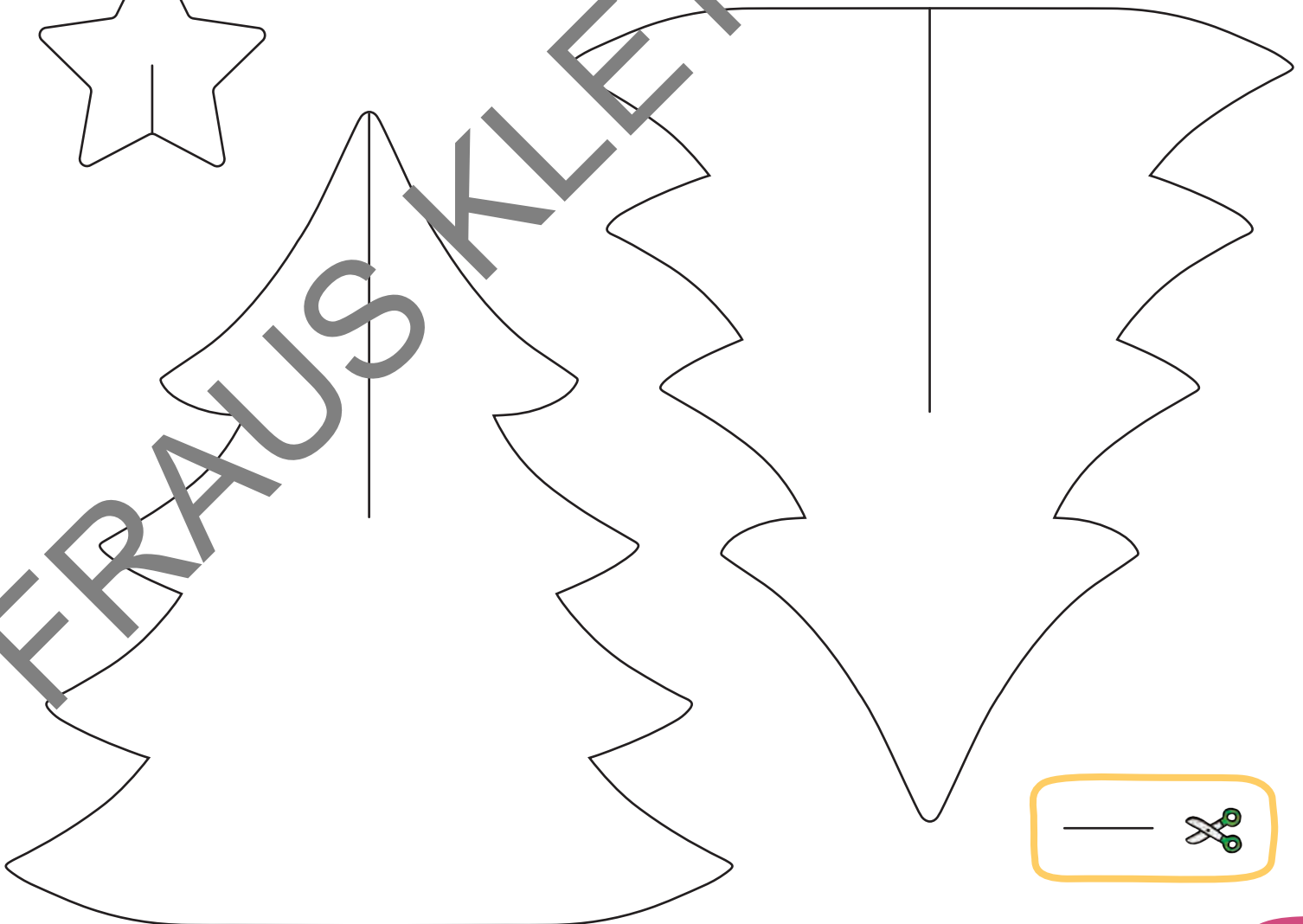
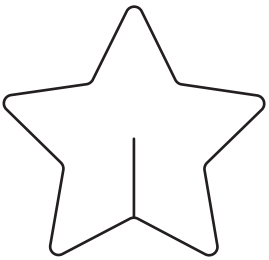

FRAUS KLETT, S.R.O.

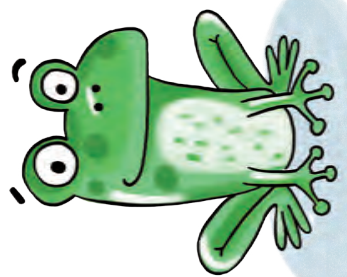
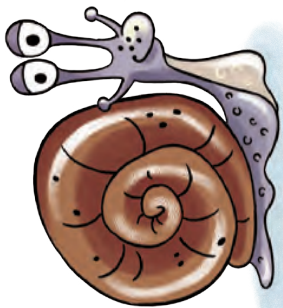
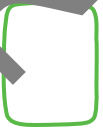
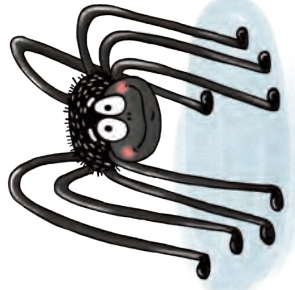
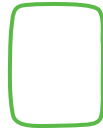
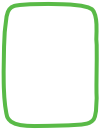
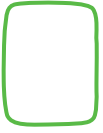
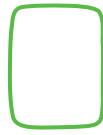
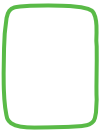

FRAUSKLETT, S.R.

O

FRAUS KLETT, S.R.O.

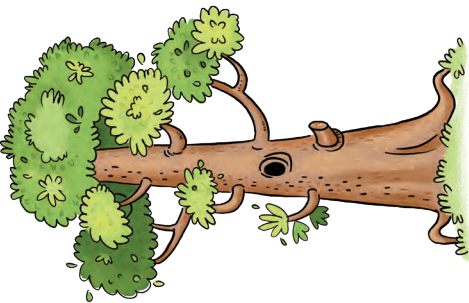
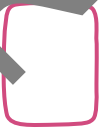
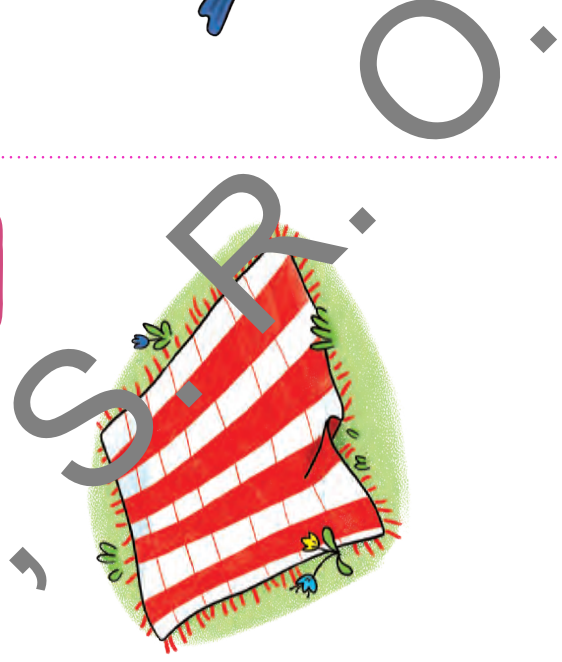
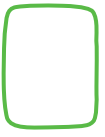

FRAUSKALETT, S.R.O.

FRAUS KLETT, S.R.O.

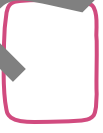
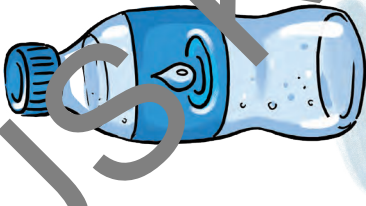
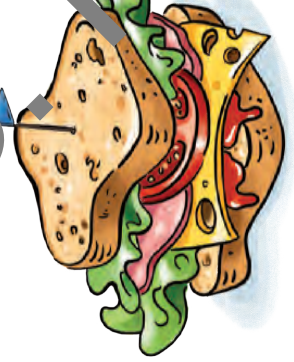
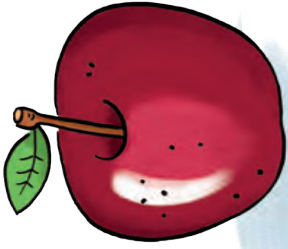

FRAUS SKLETT, S.R.O.

FRAUS KLETT, S.R.O.

# Ludo

3



FRASALETTI, S.R.L.

FRAUS KLETT, S.R.O.

# Extra 1 Halloween

1



2



1



2



3



4



# Extra 1 Halloween

3



4



# Extra 2 Christmas

1



1



2



3



4



5



2



1

2



3



4



5



# Extra 2 Christmas

3

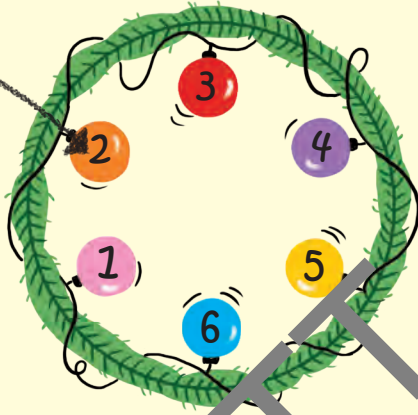

4

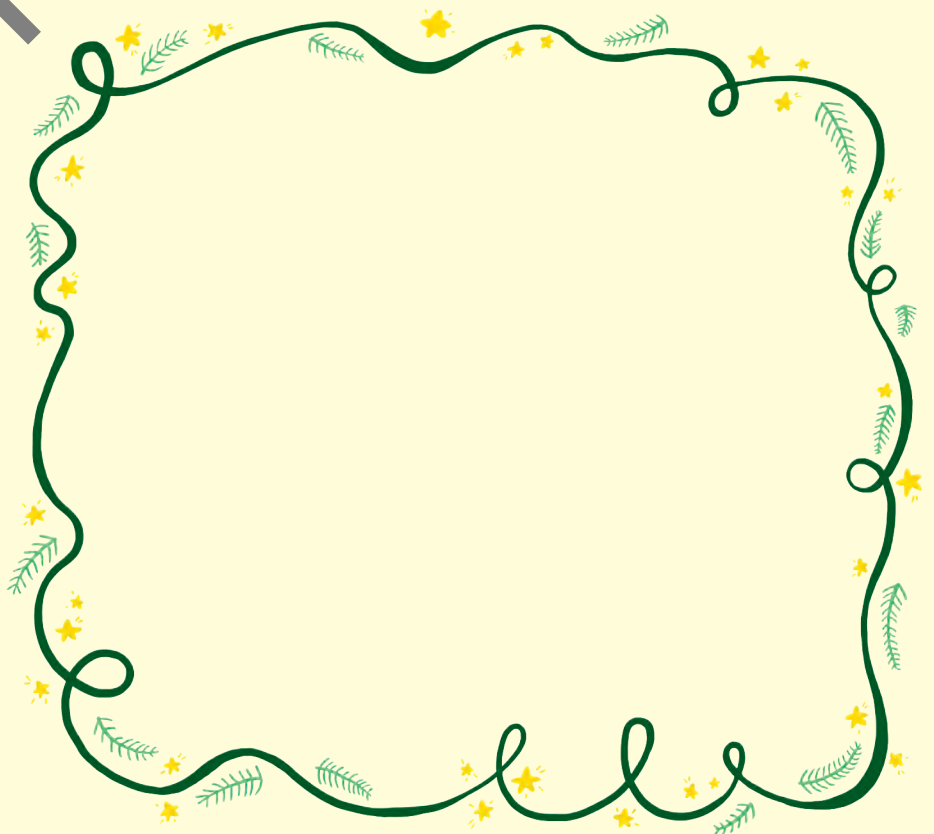

# Extra 3 Easter

1

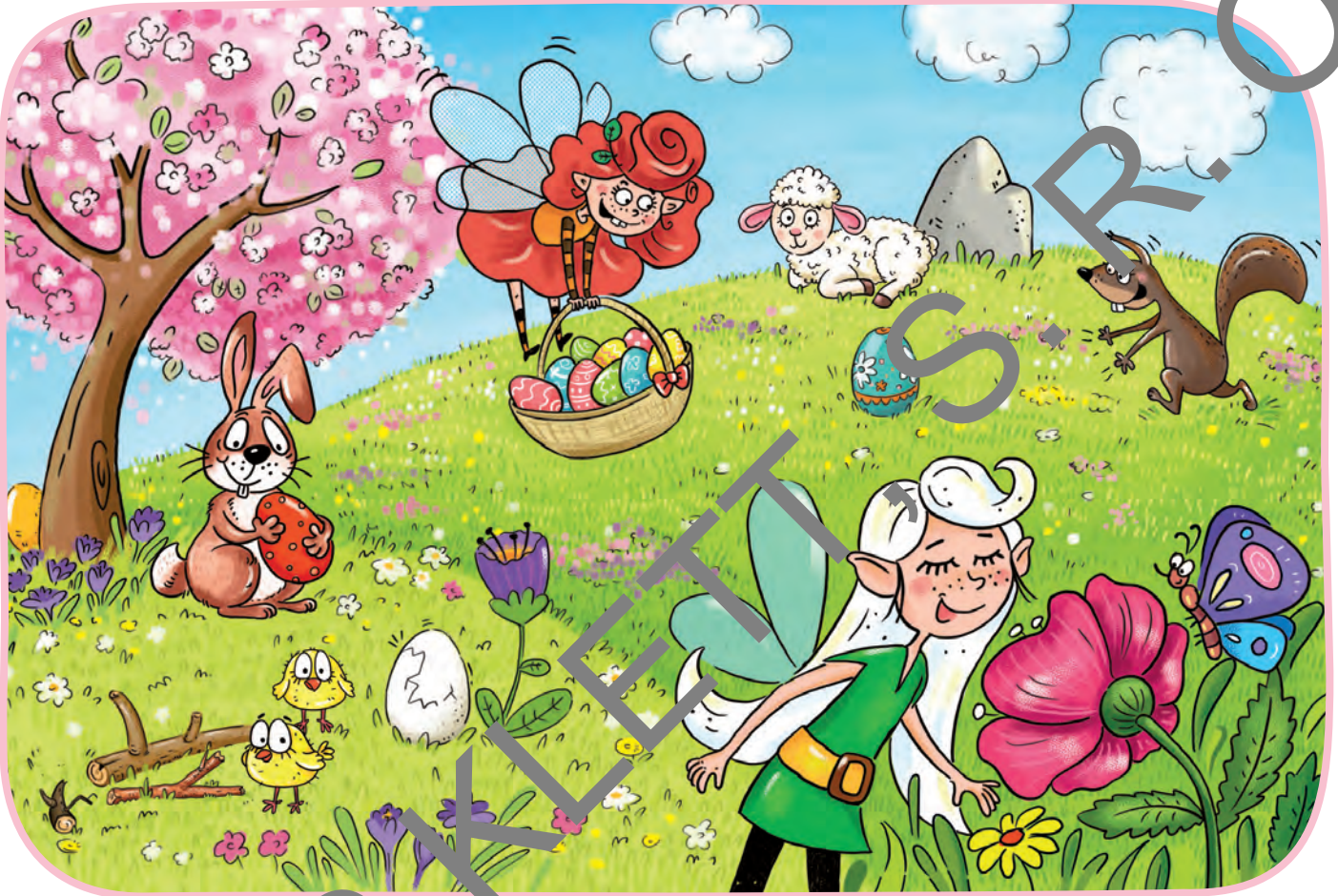

2

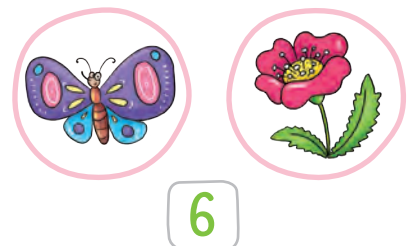
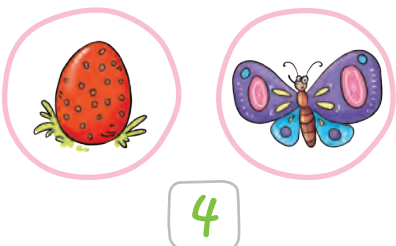
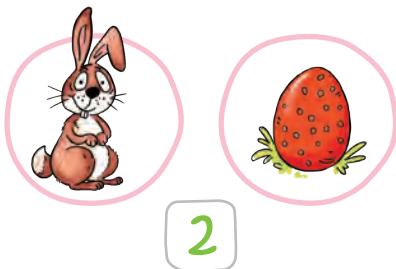

# Extra 3 Easter

3



1



2



3



4



5

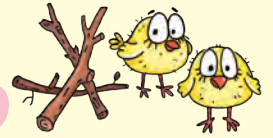

4



1



2



# Extra 4 Summer Holidays

1



1



2



3



4



2



5



6

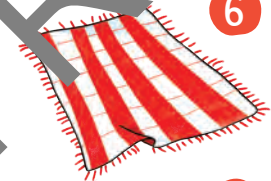

7



8



# Extra 4 Summer Holidays

3



1

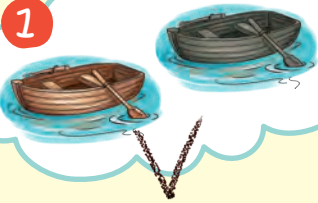

2



3



4



5



6

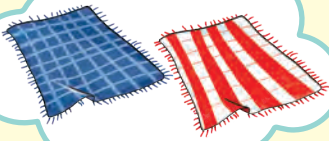

8



9



4



1

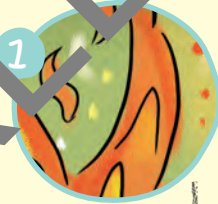

2



5



3



6



4



7



Unit 1B, page 6, exercise 3



Unit 1C, page 9, exercise 1

Extra Halloween, page 112, exercise 3

1 2 3  
4 5 6



Unit 3C, page 34, exercise 3+4

Unit 4B, page 41, exercise 1

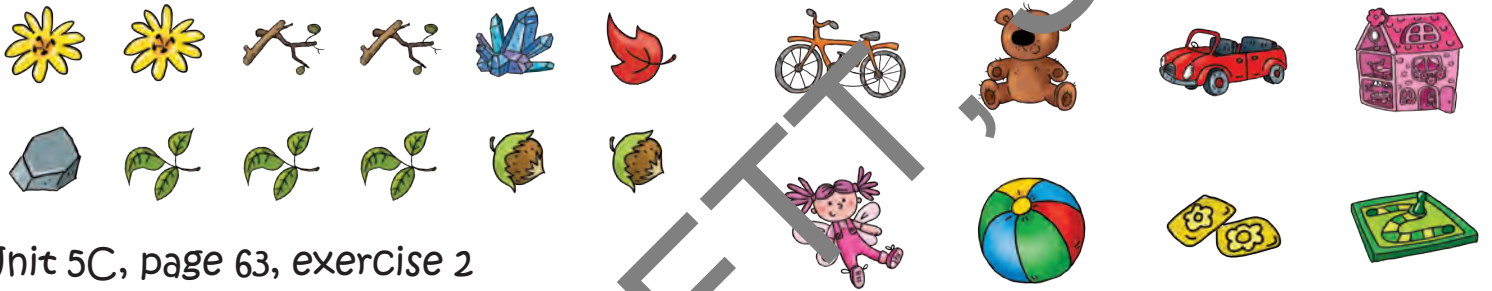

Unit 5C, page 63, exercise 2



Unit 6A, page 70, exercise 4

Unit 8B, page 95, exercise 2





FRAUS KLETT, S.R.O.

FRANZ KLETZ, S.R.O.

Franz Klett, s. r. o.  
Pobřežní 620/3, 186 00 Praha 8 – Karlín  
info@klett.sk, www.klett.sk

[v.davatelstvoklett.sk/nuttys-english](http://v.davatelstvoklett.sk/nuttys-english)

ISBN 978-80-7397-479-4

